

# 2025 W800

## PARTS DIAGRAM

### Frame Fittings

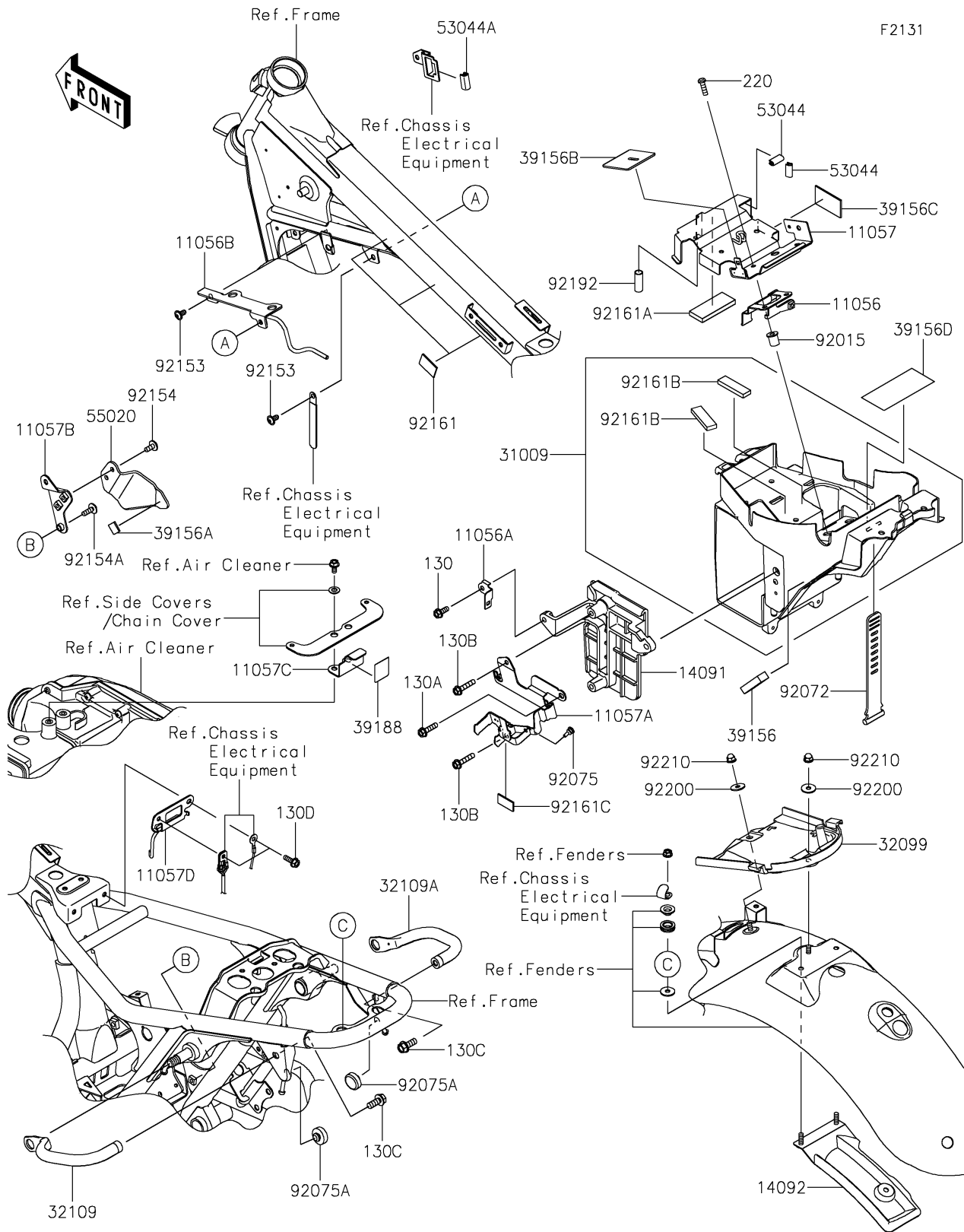

# 2025 W800

## PARTS LIST

### Frame Fittings

**ITEM NAME**

**PART NUMBER**

**QUANTITY**

---