

# 2024 VULCAN® 900 CLASSIC LT

## PARTS DIAGRAM

### Chassis Electrical Equipment

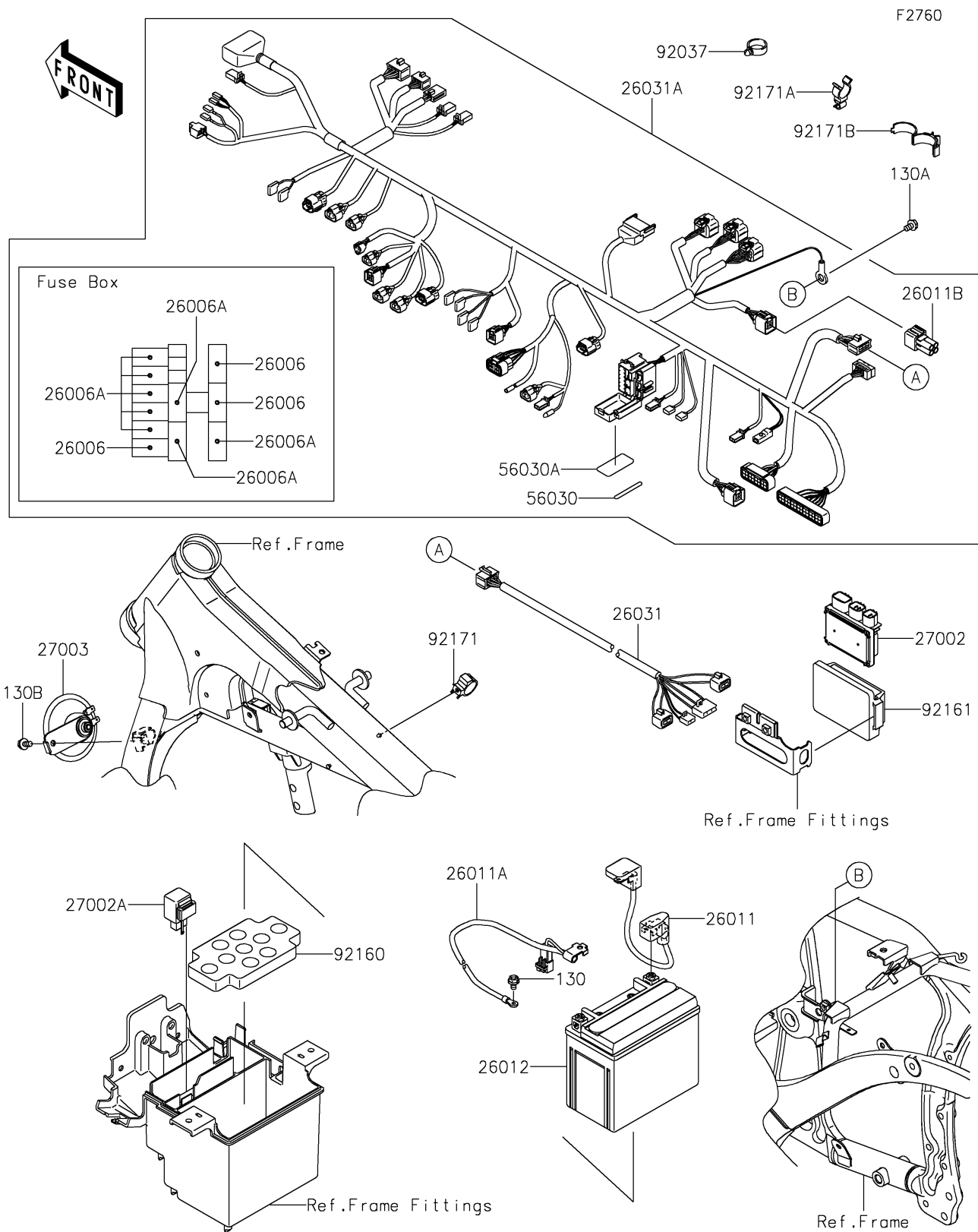

# 2024 VULCAN® 900 CLASSIC LT

## PARTS LIST

### Chassis Electrical Equipment

ITEM NAME	PART NUMBER	QUANTITY
-----------	-------------	----------

---