

# 2025 Z500 SE

## PARTS DIAGRAM

Meter(s)

F2530

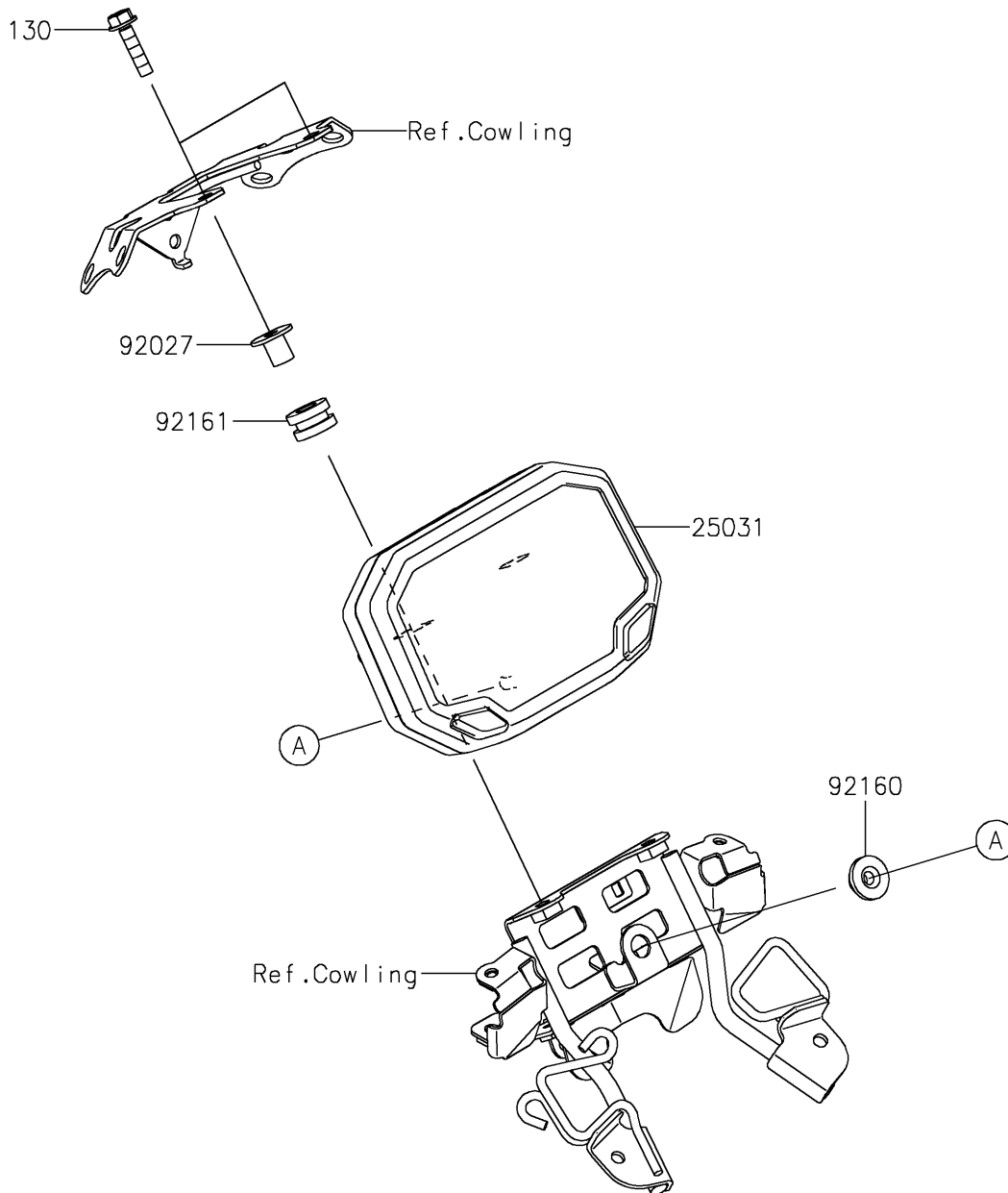

# 2025 Z500 SE

## PARTS LIST

Meter(s)

**ITEM NAME**

**PART NUMBER**

**QUANTITY**

---