

2026 Z500

PARTS DIAGRAM

Gear Change Mechanism

E1370

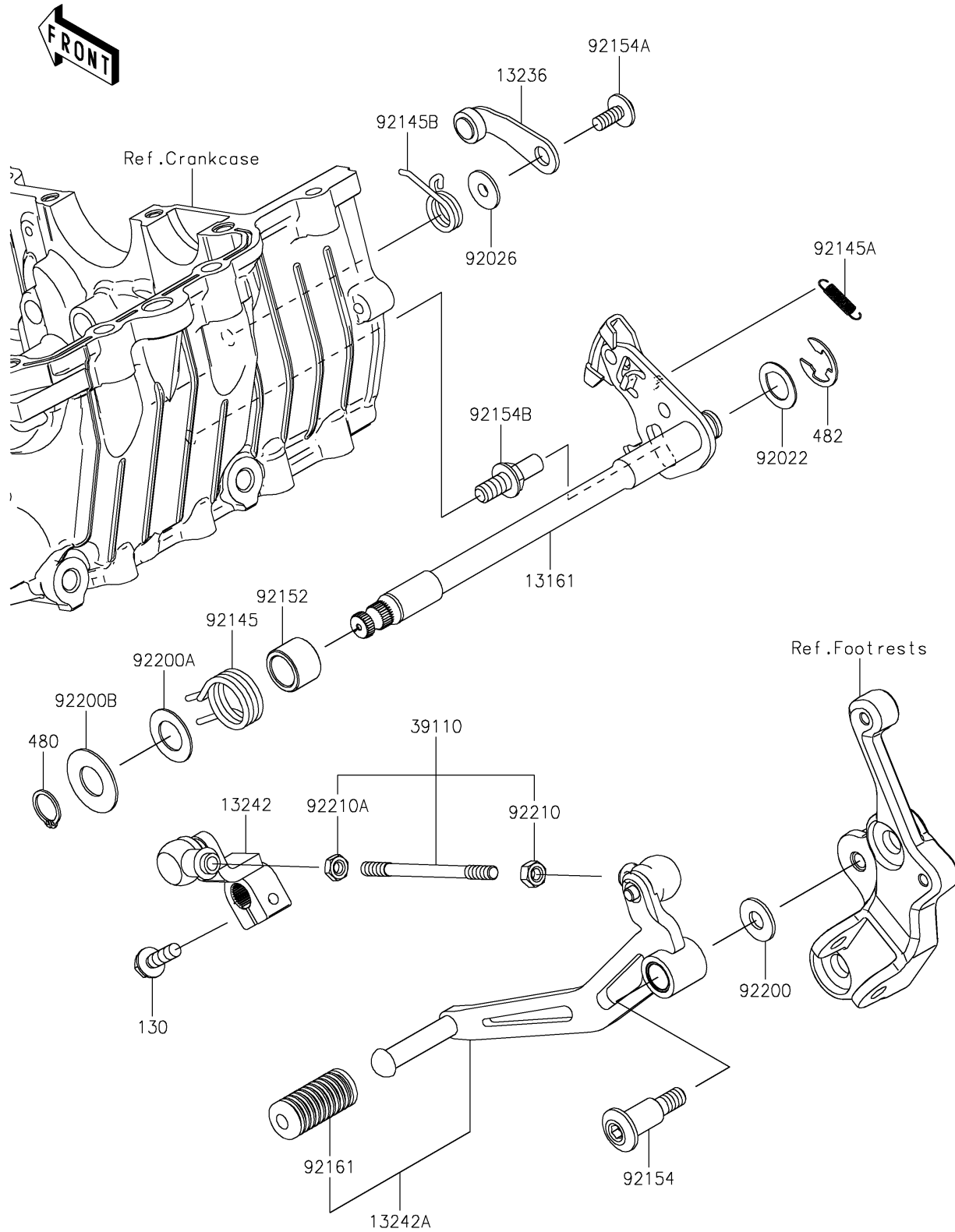

2026 Z500

PARTS LIST

Gear Change Mechanism

ITEM NAME	PART NUMBER	QUANTITY
LEVER-COMP-CHANGE SHAFT (Ref # 13161)	13161-0610	1
LEVER-COMP,POSITION (Ref # 13236)	13236-0794	1
LEVER-ASSY-CHANGE (Ref # 13242)	13242-0145	1
LEVER-ASSY-CHANGE,PEDAL (Ref # 13242A)	13242-0146	1
ROD-ASSY-TIE (Ref # 39110)	39110-0045	1
WASHER,CHANGE SHAFT (Ref # 92022)	92022-1628	1
SPACER (Ref # 92026)	92026-1217	1
SPRING,RETURN (Ref # 92145)	92145-1783	1
SPRING,PAWL RETURN (Ref # 92145A)	92145-1813	1
SPRING,DRUM POSITION (Ref # 92145B)	92145-1814	1
COLLAR,14.2X19.9X14.3 (Ref # 92152)	92152-2370	1
BOLT (Ref # 92154)	92154-2730	1
BOLT,SOCKET,6X14 (Ref # 92154A)	92154-2731	1
BOLT,RETURN SPRING (Ref # 92154B)	92154-4400	1
DAMPER,CHANGE PEDAL (Ref # 92161)	92161-1466	1
WASHER,8.5X20X1.6 (Ref # 92200)	92200-0490	1
WASHER,14.2X25X1 (Ref # 92200A)	92200-1933	1
WASHER,14.3X30X1.2 (Ref # 92200B)	92200-2295	1
NUT,6MM (Ref # 92210)	92210-1596	1
NUT,LEFT HANDED,6MM (Ref # 92210A)	92210-1597	1
BOLT-FLANGED,6X20 (Ref # 130)	130CB0620	1
CIRCLIP-TYPE-C,14MM (Ref # 480)	480J1400	1
CIRCLIP-TYPE-E,12MM (Ref # 482)	482J0200	1