

# 2026 KLR650 S

## PARTS DIAGRAM

### Turn Signals

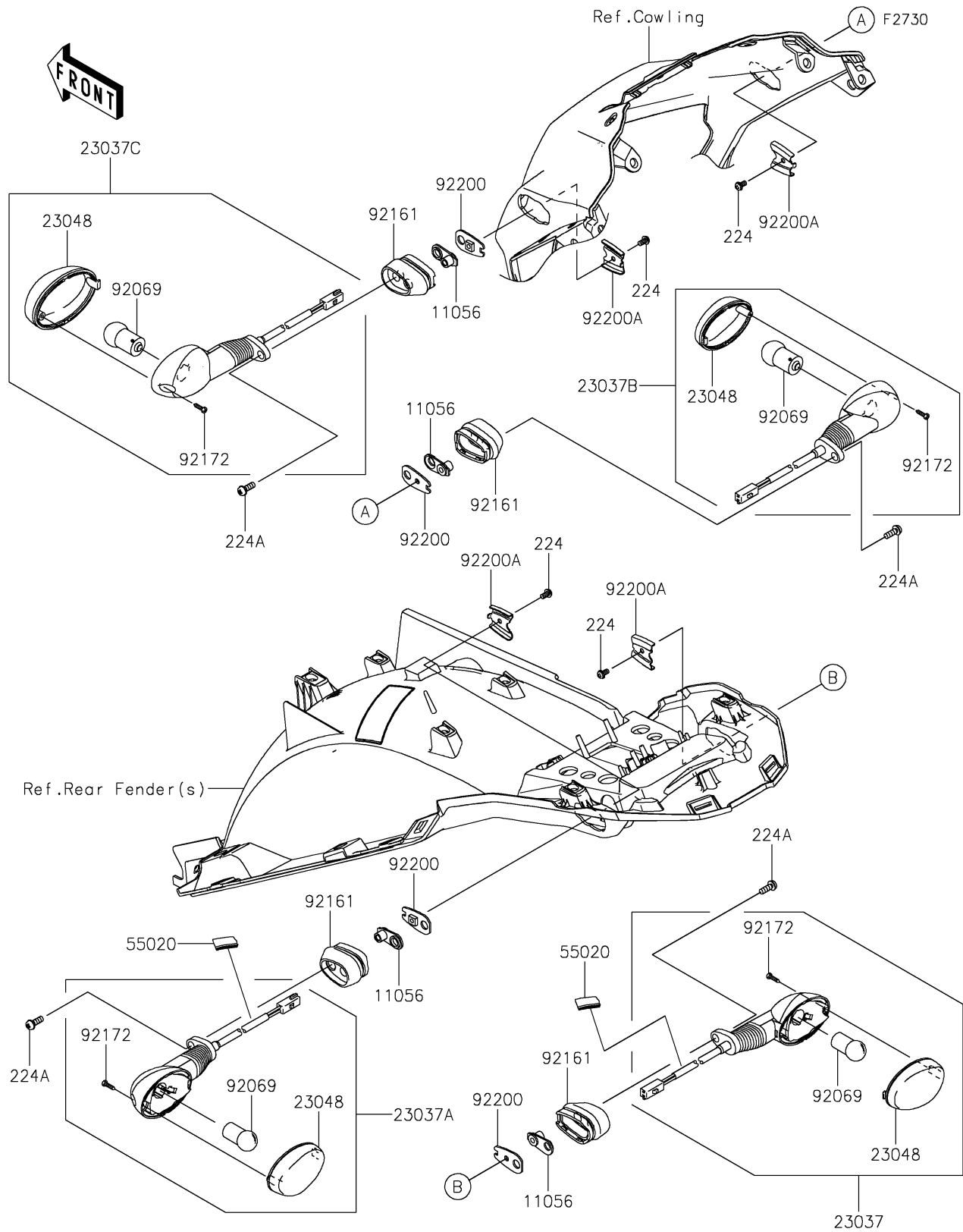

# 2026 KLR650 S

## PARTS LIST

### Turn Signals



ITEM NAME	PART NUMBER	QUANTITY
-----------	-------------	----------

---