

# 2026 KLR® 650 S

## PARTS DIAGRAM

### Water Pump

E3031

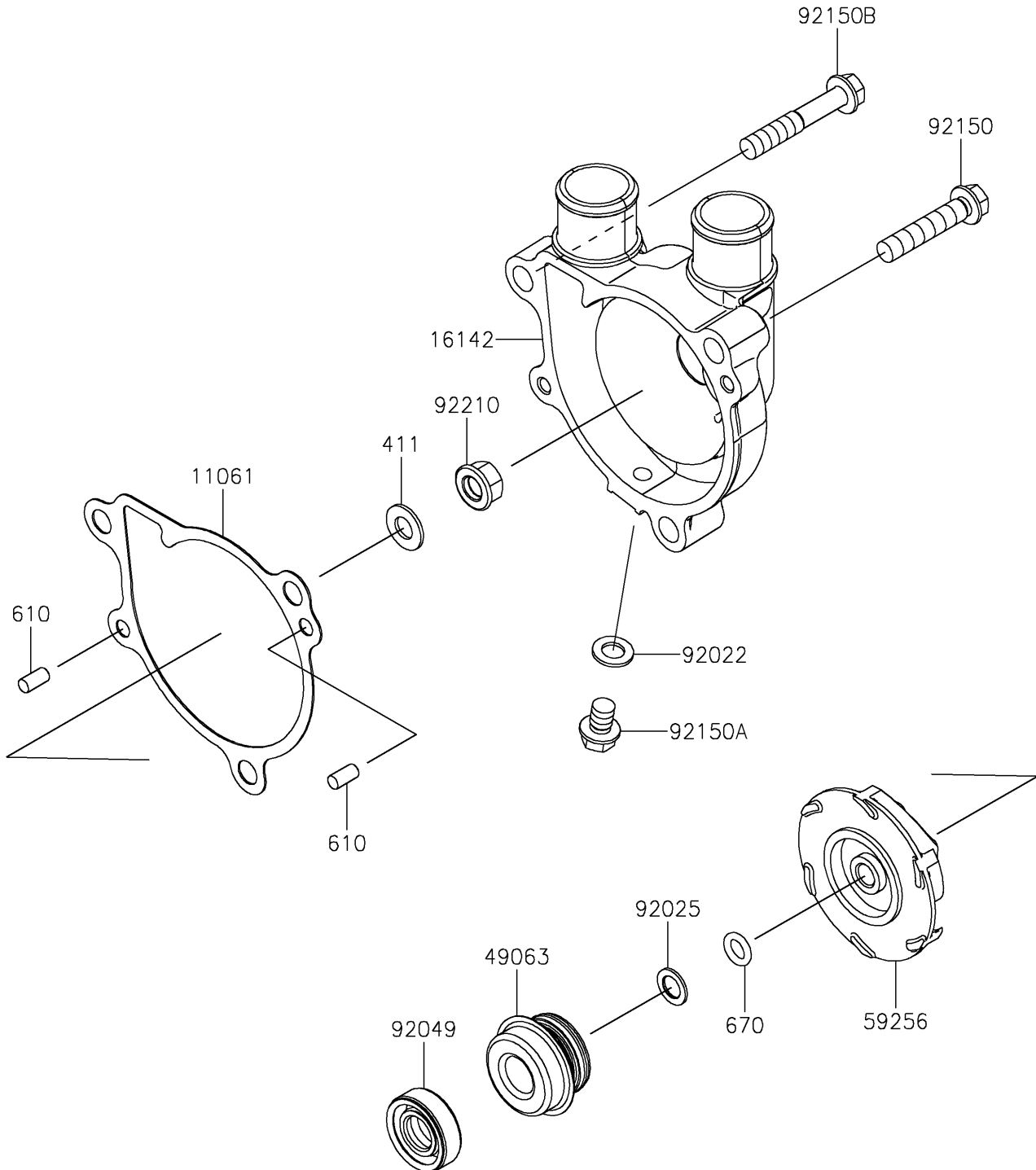

# 2026 KLR<sup>®</sup> 650 S

## PARTS LIST

### Water Pump

**Kawasaki**

Let the Good Times Roll<sup>®</sup>

**ITEM NAME**

**PART NUMBER**

**QUANTITY**

---