

2026 NINJA® 650 ABS

PARTS DIAGRAM

Brake Pedal/Torque Link

F2260

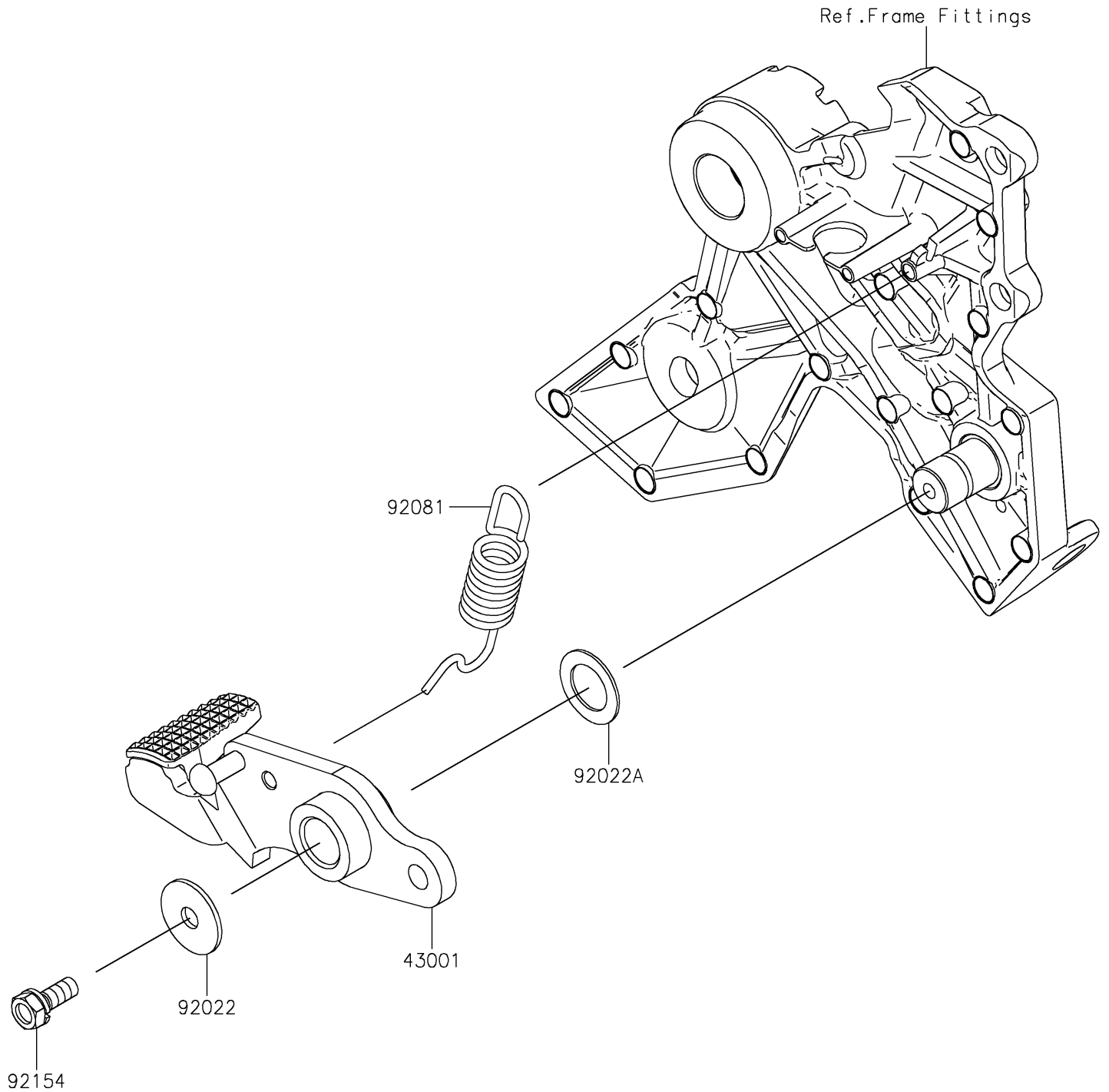

2026 NINJA® 650 ABS

PARTS LIST

Brake Pedal/Torque Link

ITEM NAME	PART NUMBER	QUANTITY
-----------	-------------	----------
