

# 2026 NINJA® 650 ABS

## PARTS DIAGRAM

### Tires

F2210

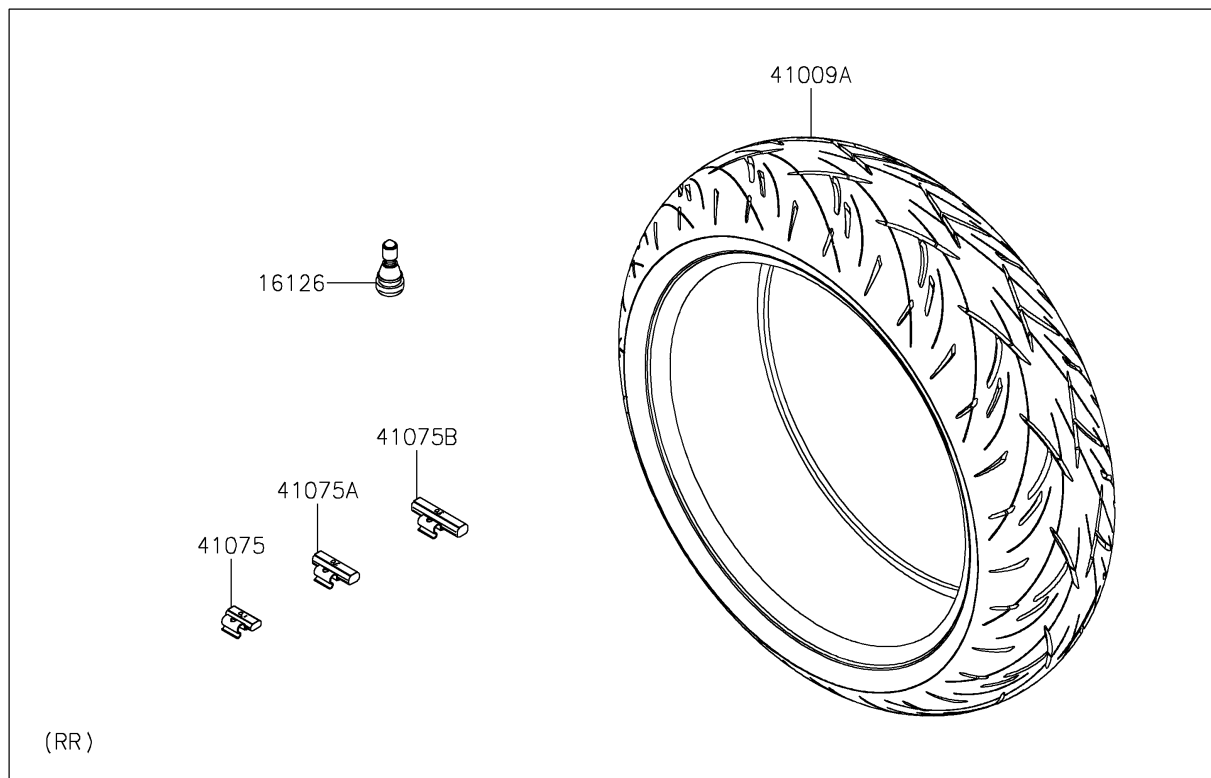
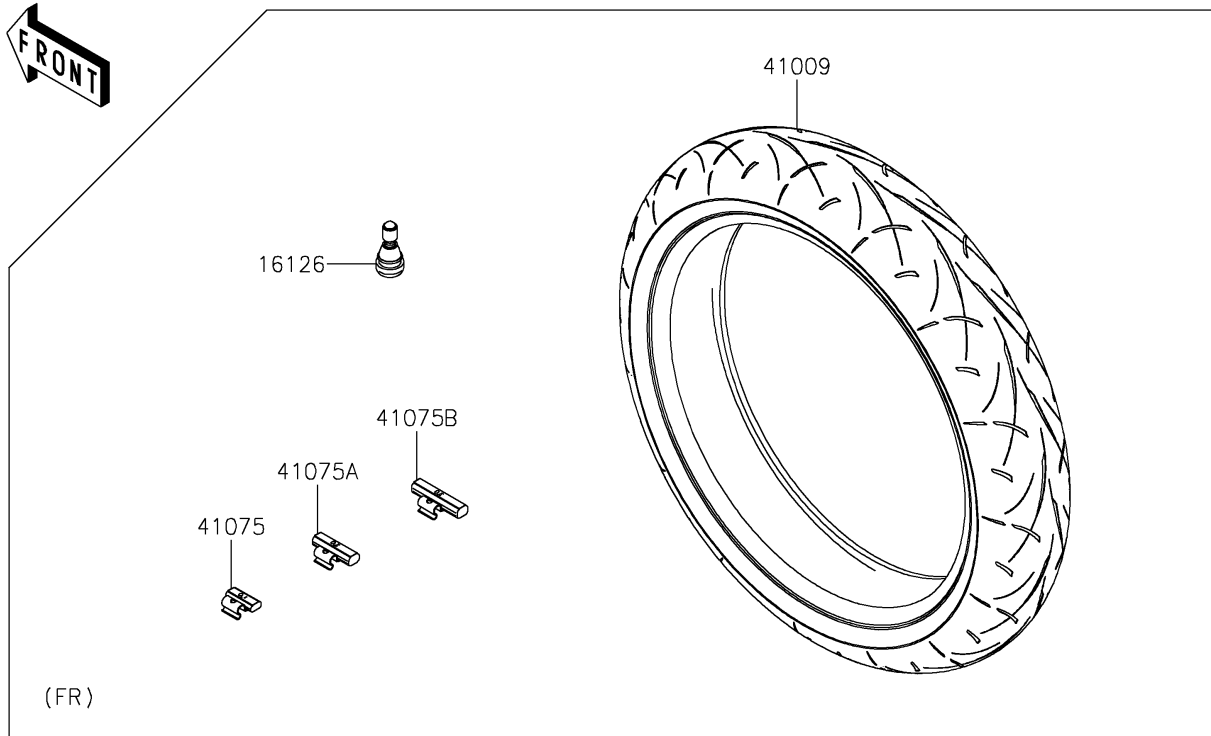

# 2026 NINJA® 650 ABS

## PARTS LIST

### Tires

**ITEM NAME**

**PART NUMBER**

**QUANTITY**

---