

# 2026 ELIMINATOR® ABS

## PARTS DIAGRAM

### Accessory(Grab Bar)

F2910D

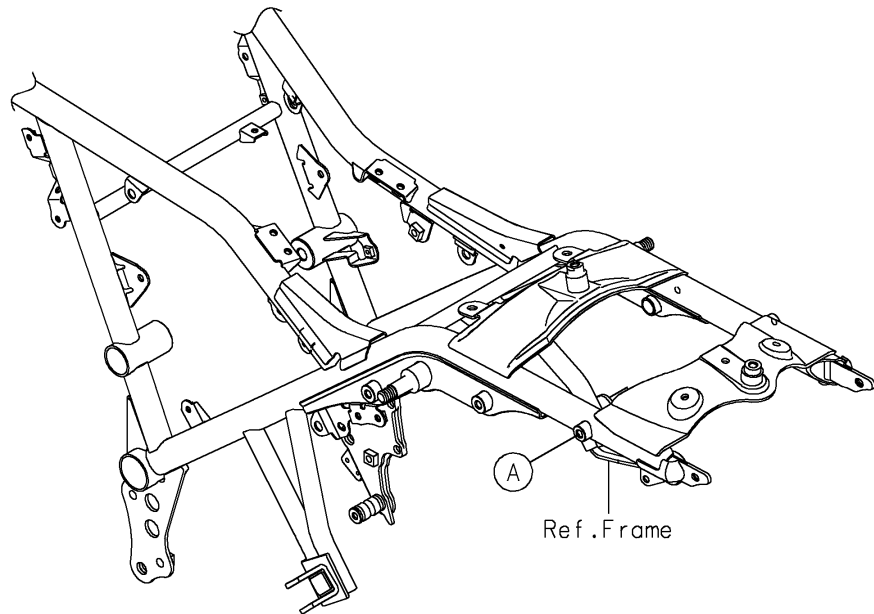

99994

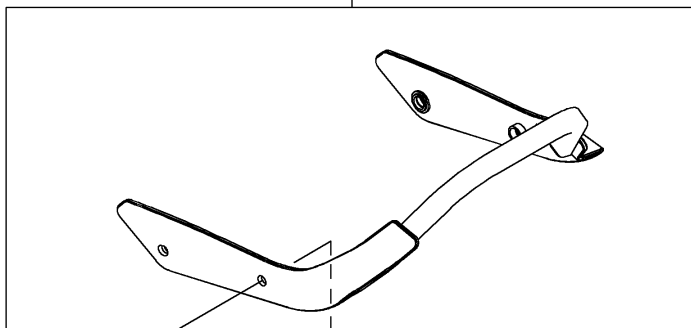

92154

Ref. Rear Fender(s)

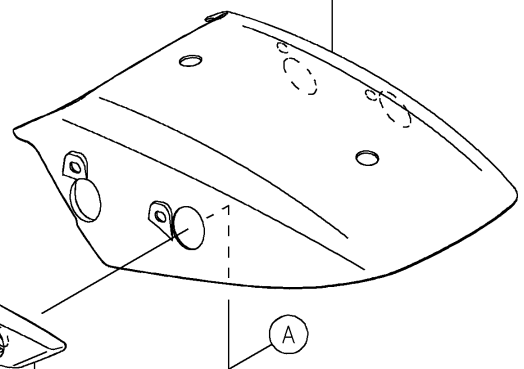

92152

Ref. Side Covers/Chain Cover

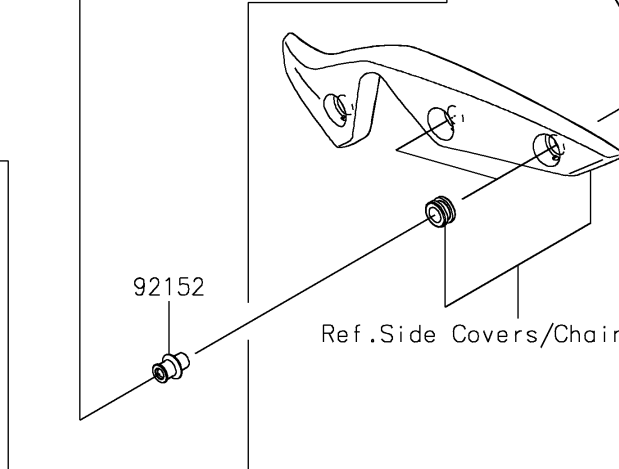

# 2026 ELIMINATOR® ABS

## PARTS LIST

Accessory(Grab Bar)

**ITEM NAME**

**PART NUMBER**

**QUANTITY**

---