

# 2026 ELIMINATOR® ABS

## PARTS DIAGRAM

Valve(s)

E1210

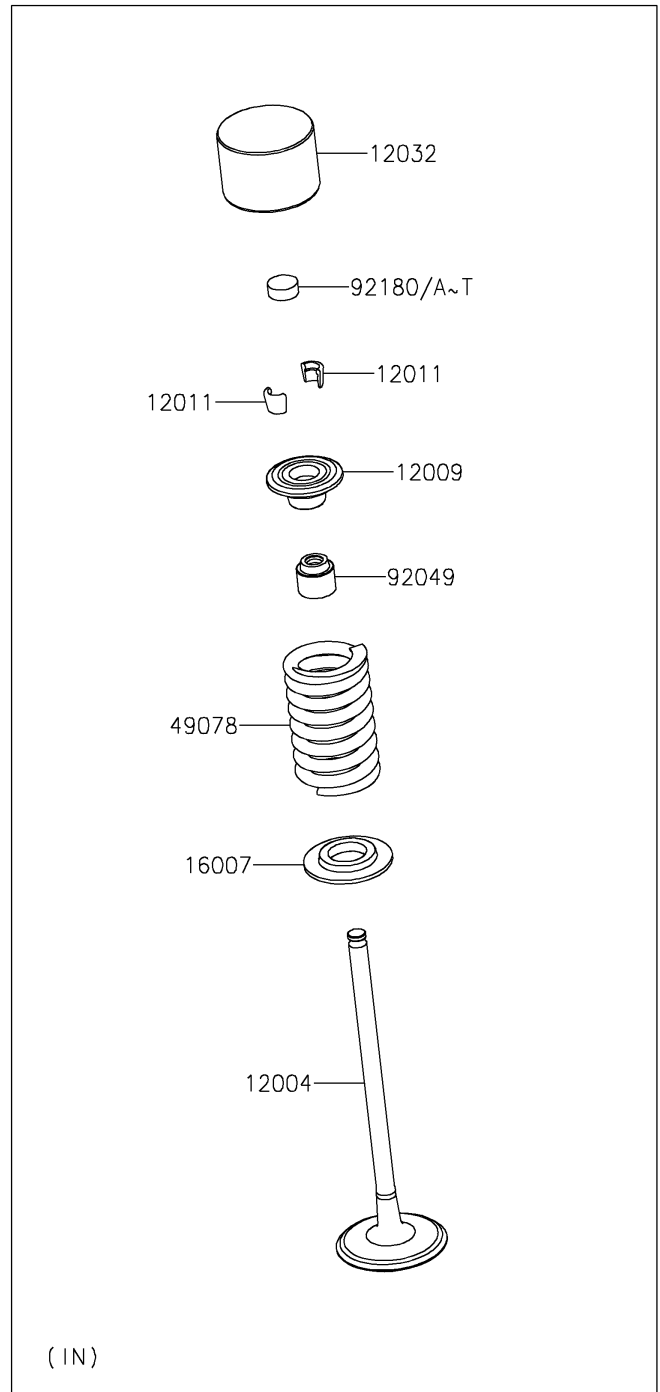

# 2026 ELIMINATOR® ABS

## PARTS LIST

Valve(s)

**ITEM NAME**

**PART NUMBER**

**QUANTITY**

---