

2024 Z H2 SE

PARTS DIAGRAM

Oil Pump/Oil Filter

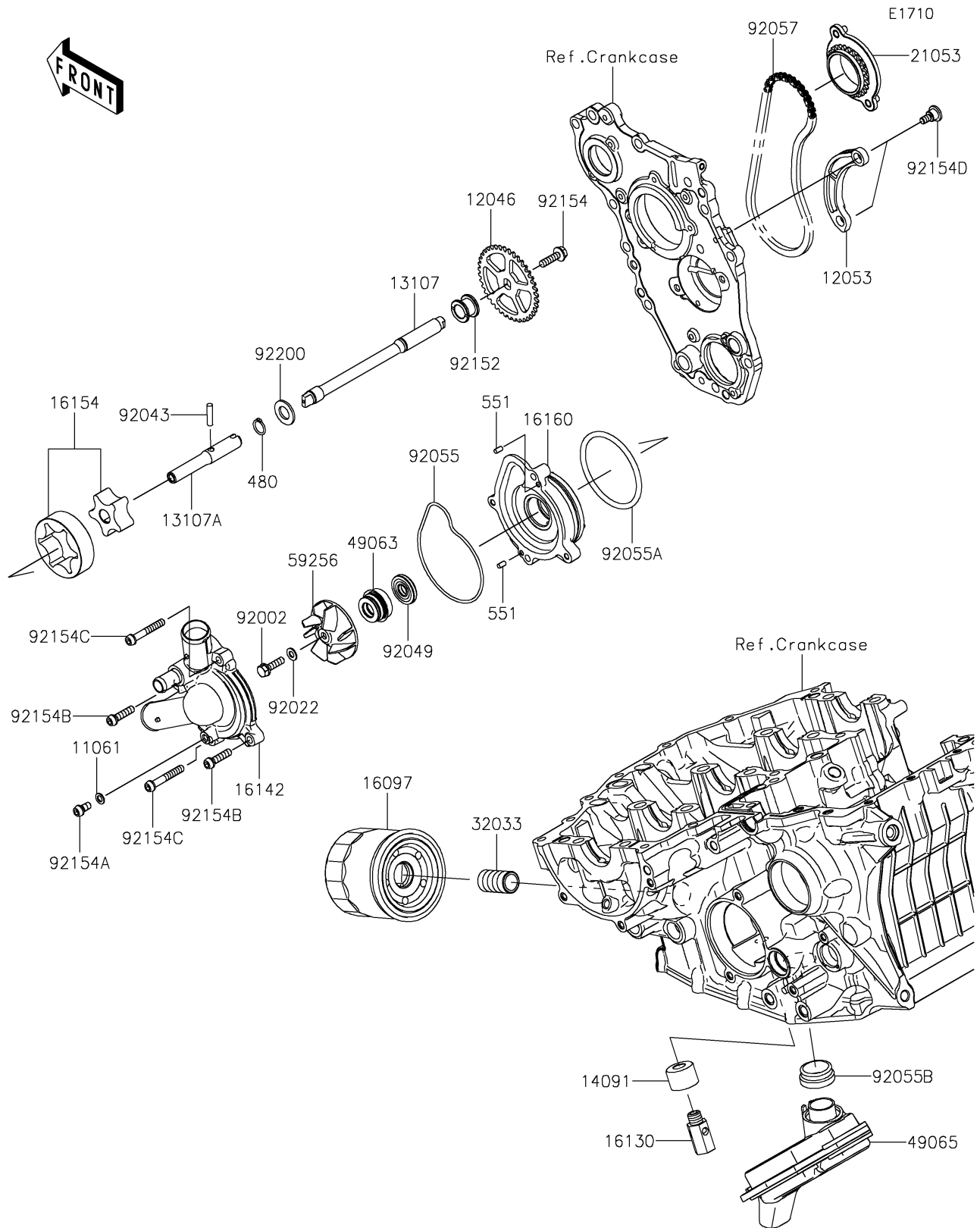

2024 Z H2 SE

PARTS LIST

Oil Pump/Oil Filter

ITEM NAME	PART NUMBER	QUANTITY
GASKET (Ref # 11061)	11061-0107	1
SPROCKET,PUMP DRIVEN,39T (Ref # 12046)	12046-0602	1
GUIDE-CHAIN (Ref # 12053)	12053-0302	1
SHAFT,RH (Ref # 13107)	13107-0809	1
SHAFT,LH (Ref # 13107A)	13107-0810	1
COVER,VALVE (Ref # 14091)	14091-0497	1
FILTER-ASSY-OIL (Ref # 16097)	16097-0009	1
VALVE-ASSY-RELIEF (Ref # 16130)	16130-0005	1
COVER-PUMP,WATER (Ref # 16142)	16142-0733	1
ROTOR-PUMP,OIL (Ref # 16154)	16154-0723	1
BODY,WATER PUMP (Ref # 16160)	16160-0799	1
SPROCKET-ASSY,PUMP DRIVE,27T (Ref # 21053)	21053-0009	1
PIPE,OIL FILTER (Ref # 32033)	32033-1535	1
SEAL-MECHANICAL (Ref # 49063)	49063-1055	1
FILTER-OIL (Ref # 49065)	49065-0037	1
IMPELLER (Ref # 59256)	59256-0011	1
BOLT,6X22 (Ref # 92002)	92002-1154	1
WASHER,6.1X12X1 (Ref # 92022)	92022-077	1
PIN,5X21.8 (Ref # 92043)	92043-1518	1
SEAL-OIL (Ref # 92049)	92049-0778	1
RING-O,WATER PUMP (Ref # 92055)	92055-0208	1
RING-O,68.2X2.4 (Ref # 92055A)	92055-1338	1
RING-O,OIL FILTER (Ref # 92055B)	92055-1503	1
CHAIN,92RH2005-76M (Ref # 92057)	92057-0635	1
COLLAR (Ref # 92152)	92152-1935	1
BOLT,FLANGED,6X22 (Ref # 92154)	92154-0387	1
BOLT,SOCKET,6X12 (Ref # 92154A)	92154-1453	1
BOLT,SOCKET,6X25 (Ref # 92154B)	92154-1457	2
BOLT,SOCKET,6X40 (Ref # 92154C)	92154-1459	2

2024 Z H2 SE

PARTS LIST

Oil Pump/Oil Filter

ITEM NAME	PART NUMBER	QUANTITY
BOLT (Ref # 92154D)	92154-1651	2
WASHER,13X24X2 (Ref # 92200)	92200-0451	1
CIRCLIP-TYPE-C,13MM (Ref # 480)	480J1300	1
PIN-DOWEL,4X8 (Ref # 551)	551A0408	2