

# 1999 Ninja<sup>®</sup> ZX<sup>™</sup>-9R

## PARTS DIAGRAM

### Starter Motor

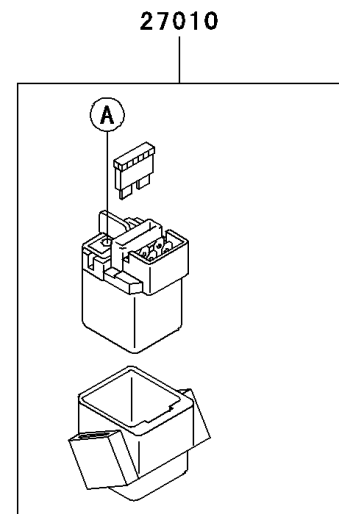
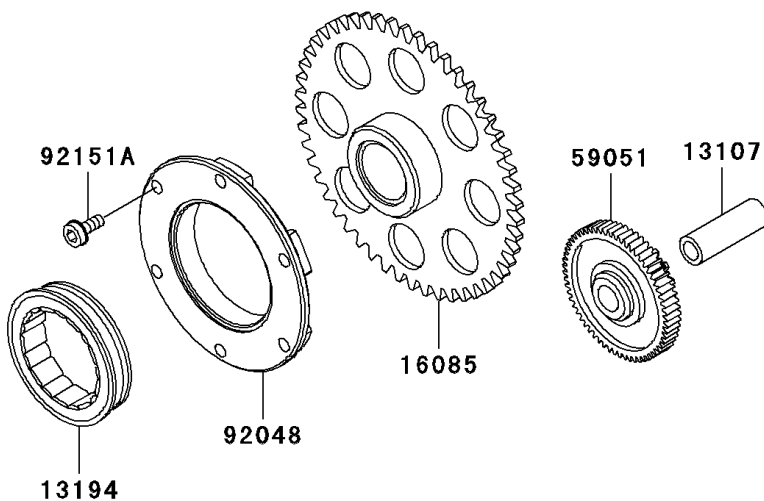
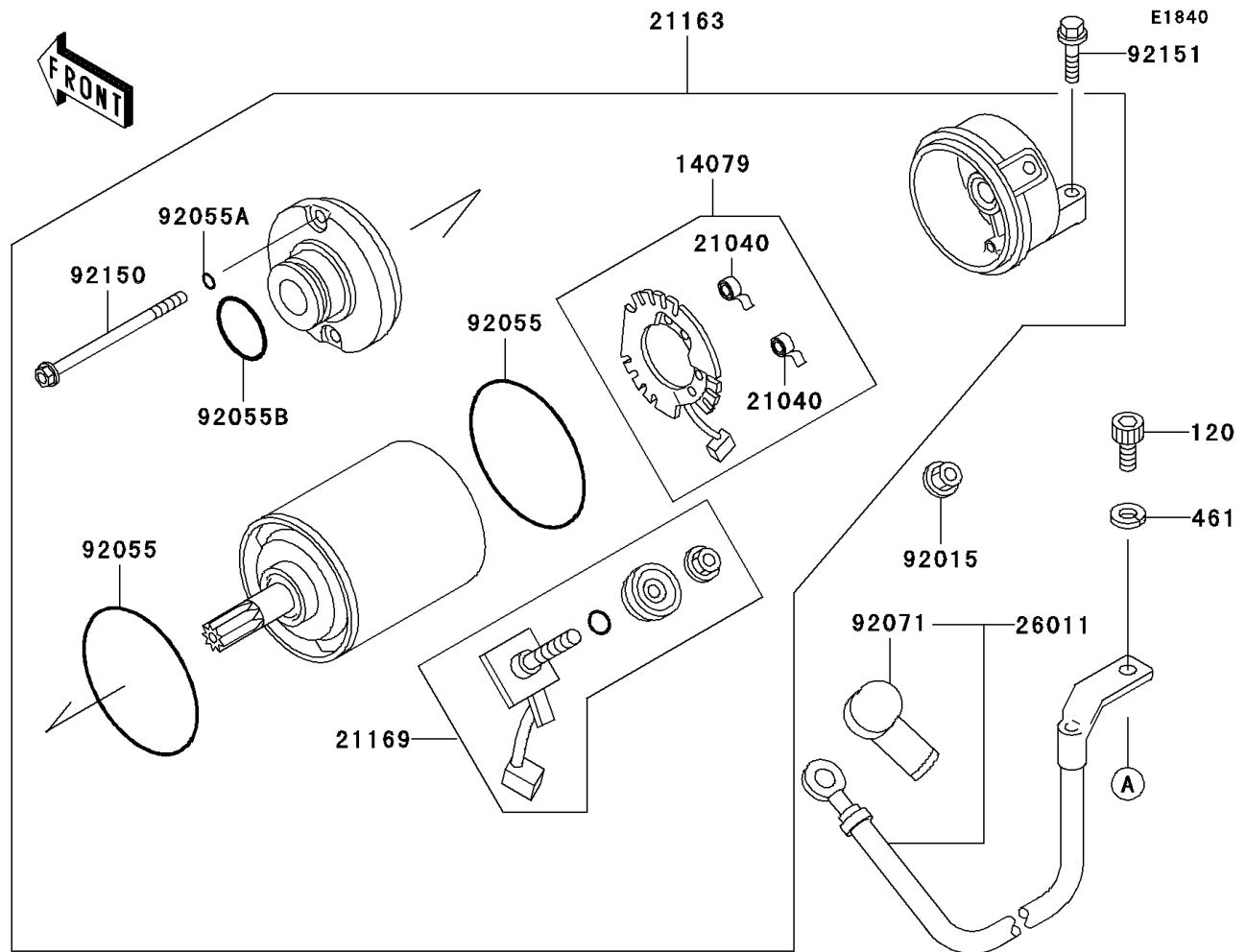

# 1999 Ninja<sup>®</sup> ZX<sup>™</sup>-9R

## PARTS LIST

### Starter Motor

**ITEM NAME**

**PART NUMBER**

**QUANTITY**

---