

1997 Ninja® ZX™-7R

PARTS DIAGRAM

Optional Parts(ZX-7RR Battery)

F2890B

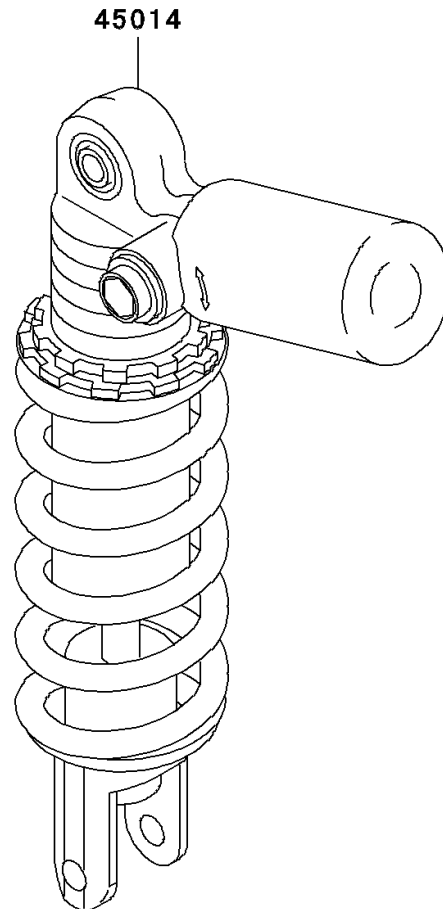
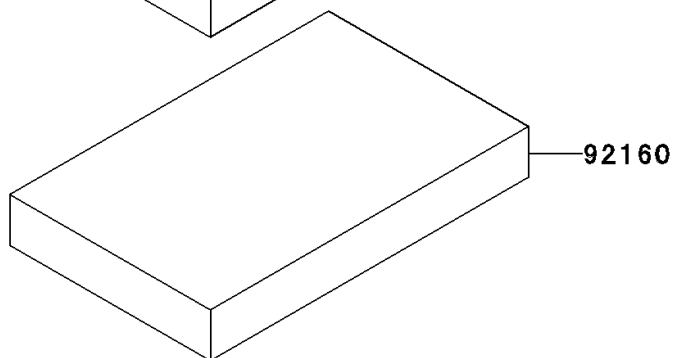
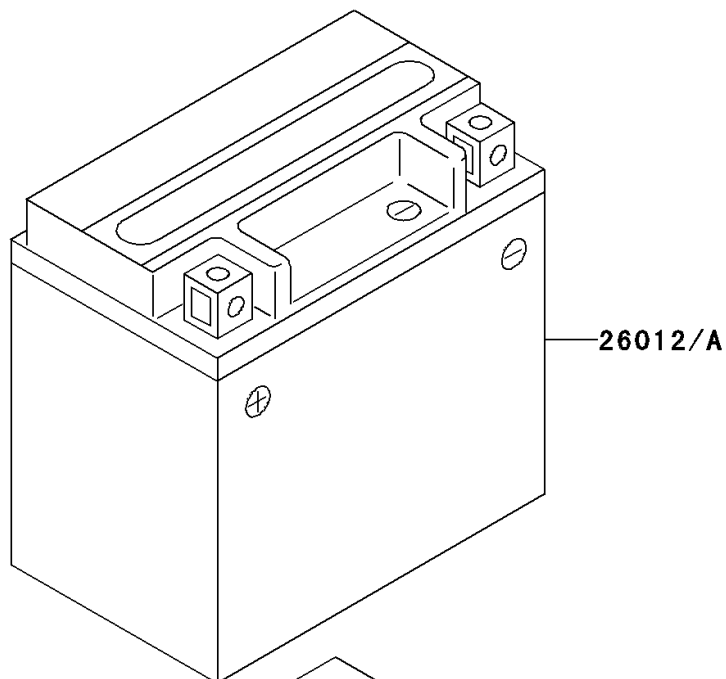

1997 Ninja® ZX™-7R

PARTS LIST

Optional Parts(ZX-7RR Battery)

ITEM NAME	PART NUMBER	QUANTITY
BATTERY,YTX9-BS,12V 8AH (Ref # 26012)	26012-1282	1
SHOCKABSORBER,ZX-7RR (Ref # 45014)	45014-1614	1
DAMPER,BATTERY (Ref # 92160)	92160-1284	1