

# 2026 MULE 4000 TRANS™

## PARTS DIAGRAM

### Gear Box

E1450

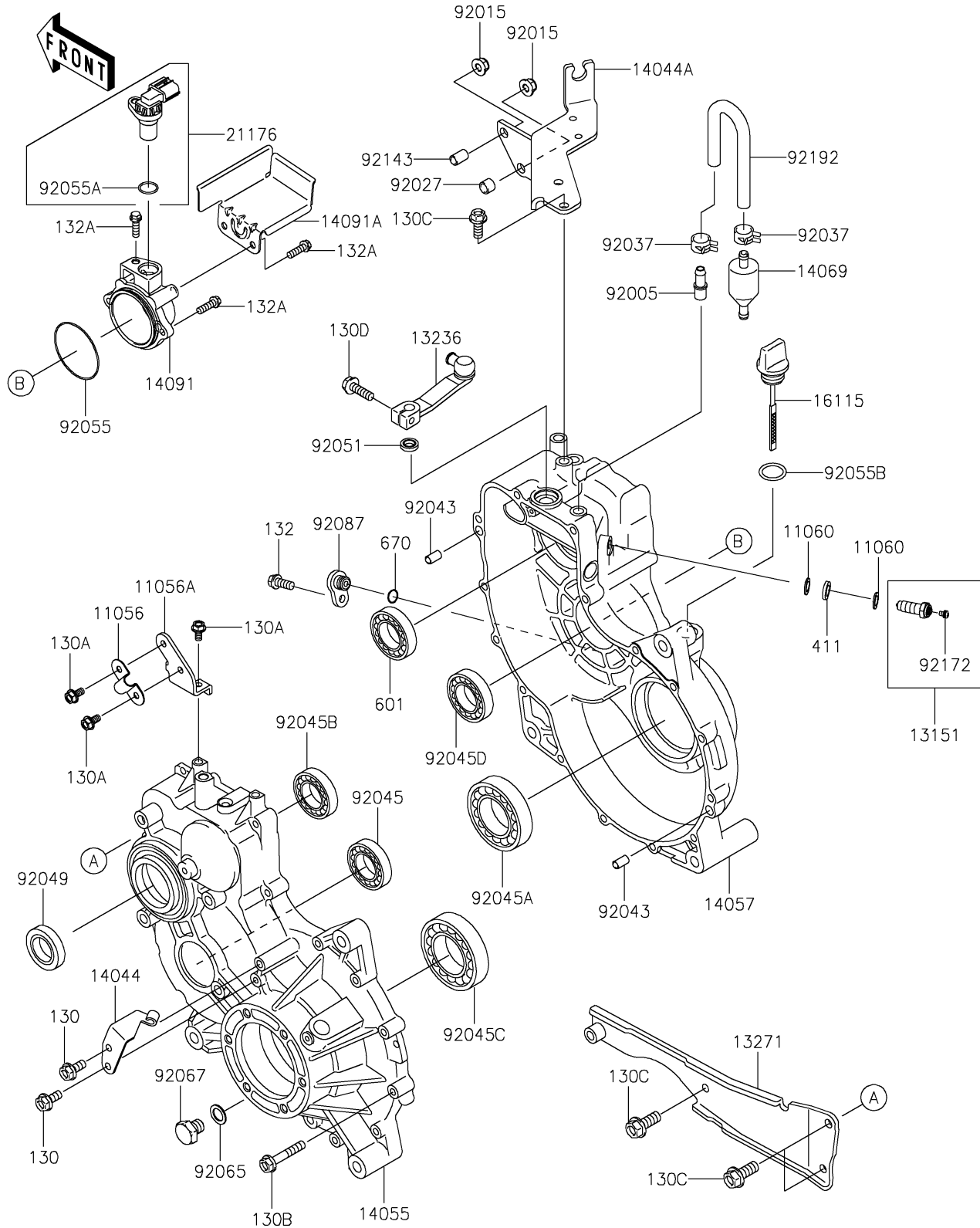

# 2026 MULE 4000 TRANS™

## PARTS LIST

### Gear Box

**ITEM NAME**

**PART NUMBER**

**QUANTITY**

---