

# 2026 KX™ 450

## PARTS DIAGRAM

### Clutch

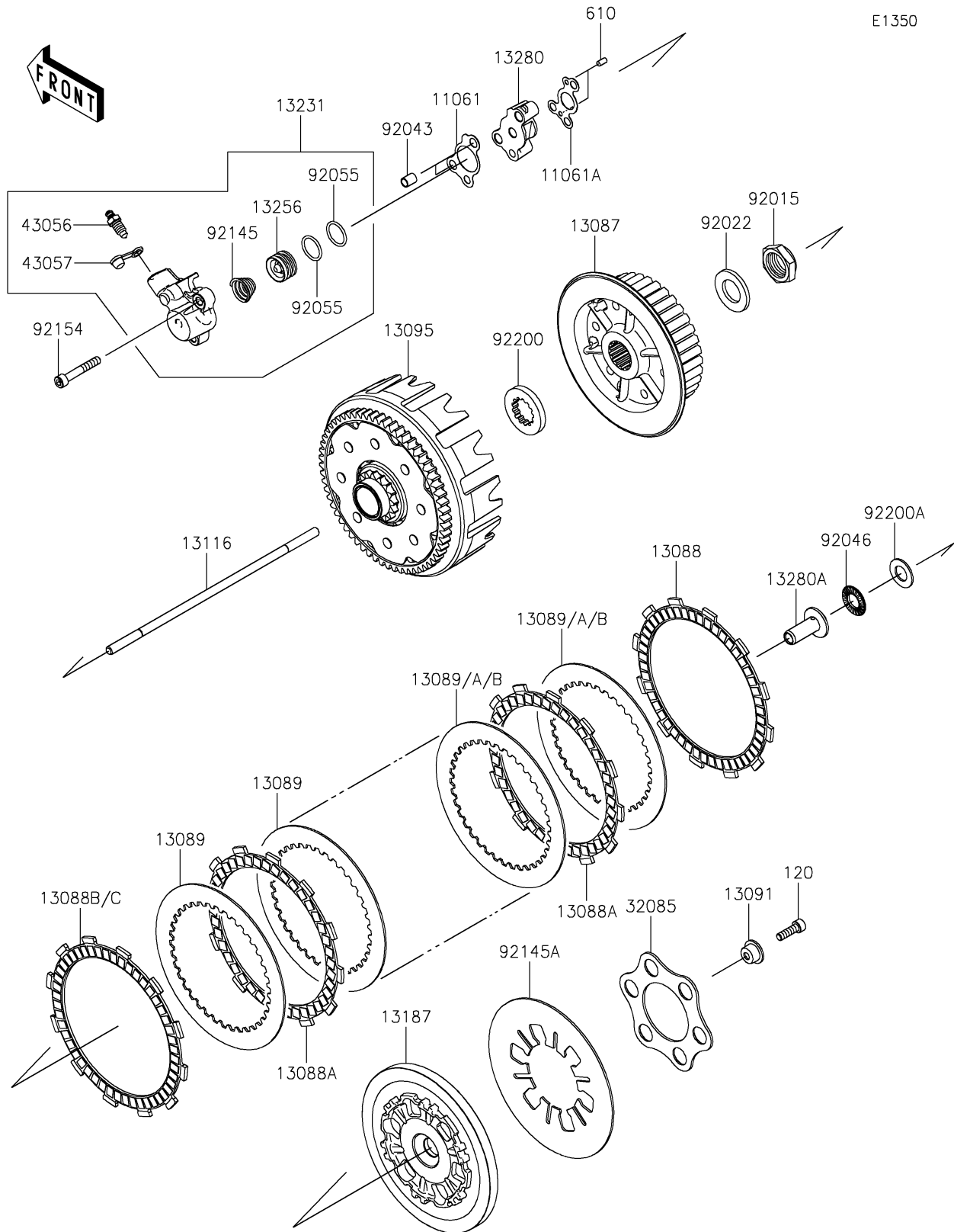

# 2026 KX™ 450

## PARTS LIST

### Clutch

**ITEM NAME**

**PART NUMBER**

**QUANTITY**

---