

# 2025 KLX300

## PARTS DIAGRAM

### Chassis Electrical Equipment

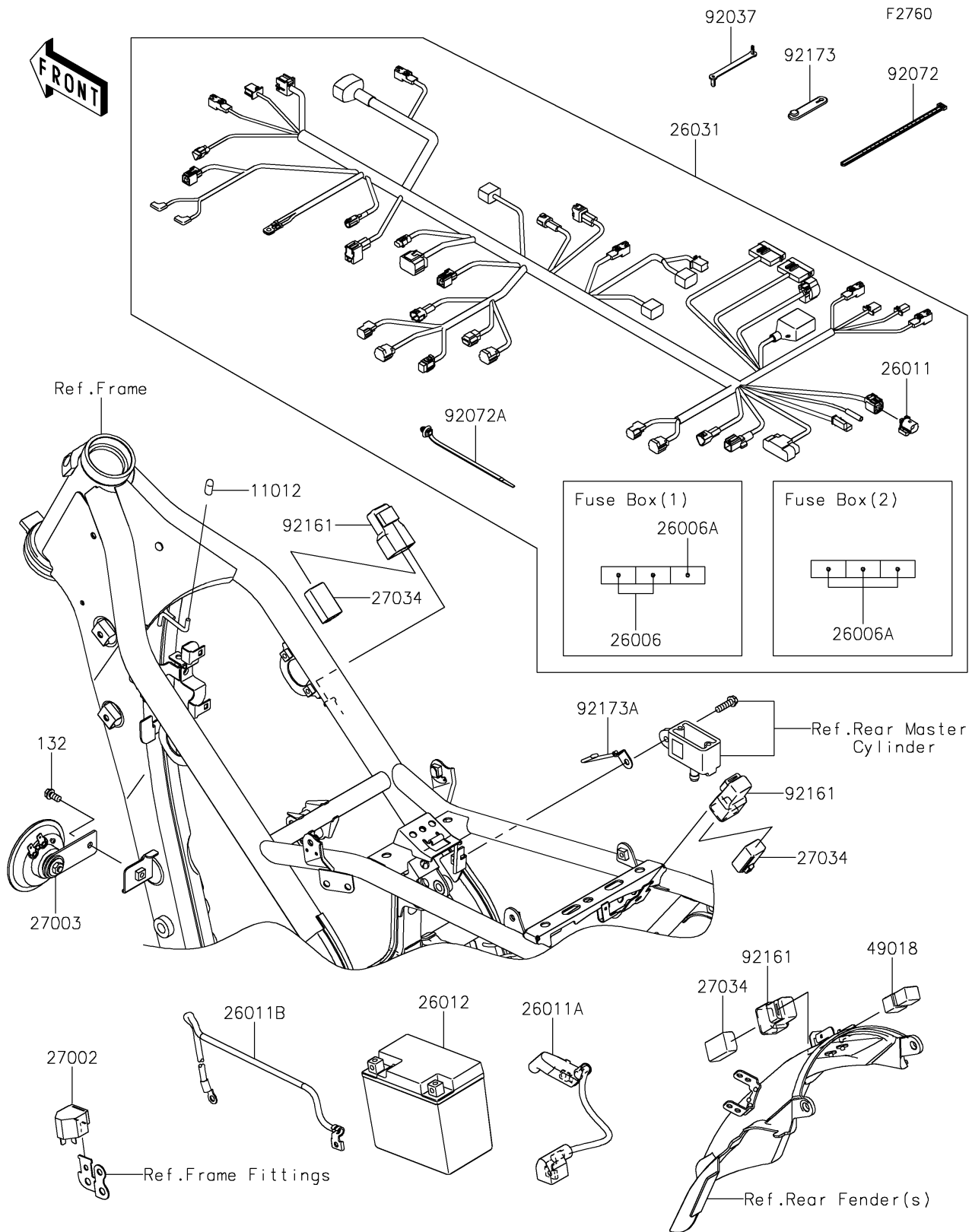

# 2025 KLX300

## PARTS LIST

### Chassis Electrical Equipment

**ITEM NAME**

**PART NUMBER**

**QUANTITY**

---