

2025 KLX300

PARTS DIAGRAM

Gear Change Mechanism

E1370

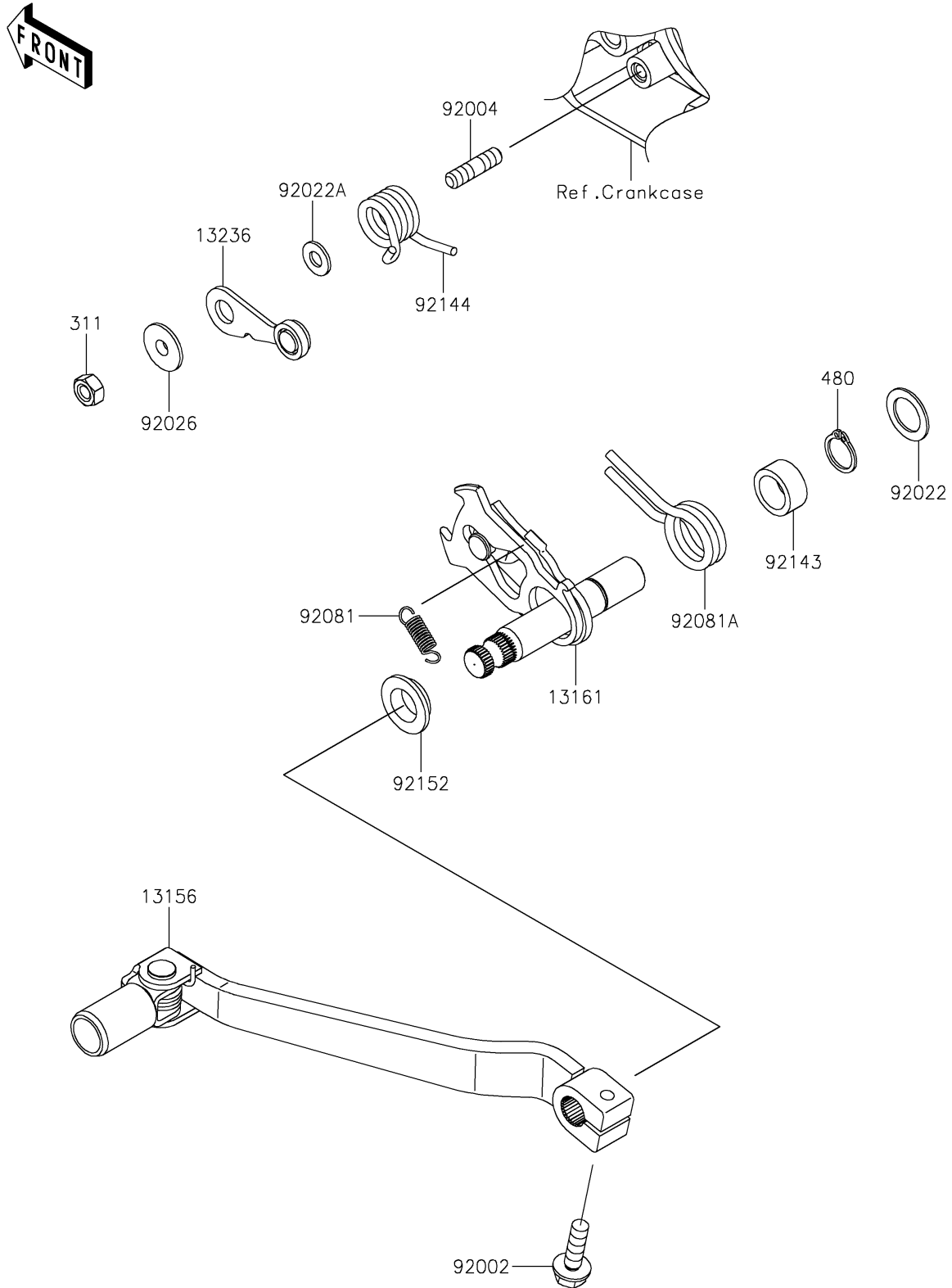

2025 KLX300

PARTS LIST

Gear Change Mechanism

ITEM NAME	PART NUMBER	QUANTITY
LEVER-CHANGE,PEDAL (Ref # 13156)	13156-1480	1
LEVER-COMP-CHANGE SHAFT (Ref # 13161)	13161-1214	1
LEVER-COMP,NEUTRAL POSITION (Ref # 13236)	13236-1209	1
BOLT,6X20 (Ref # 92002)	92002-1237	1
STUD,6X12 (Ref # 92004)	92004-0032	1
WASHER,13.3X20X1 (Ref # 92022)	92022-1496	1
WASHER,6X12.8X1.2 (Ref # 92022A)	92022-1827	1
SPACER (Ref # 92026)	92026-1217	1
SPRING,CHANGE LEVER (Ref # 92081)	92081-076	1
SPRING,TENSION (Ref # 92081A)	92081-1129	1
COLLAR (Ref # 92143)	92143-1148	1
SPRING (Ref # 92144)	92144-1695	1
COLLAR (Ref # 92152)	92152-1075	1
NUT-HEX,6MM (Ref # 311)	311BA0600	1
CIRCLIP-TYPE-C,13MM (Ref # 480)	480J1300	1