

2026 MULE PRO-FXT™ 1000 PLATINUM RANCH EDITION

PARTS DIAGRAM Ignition System

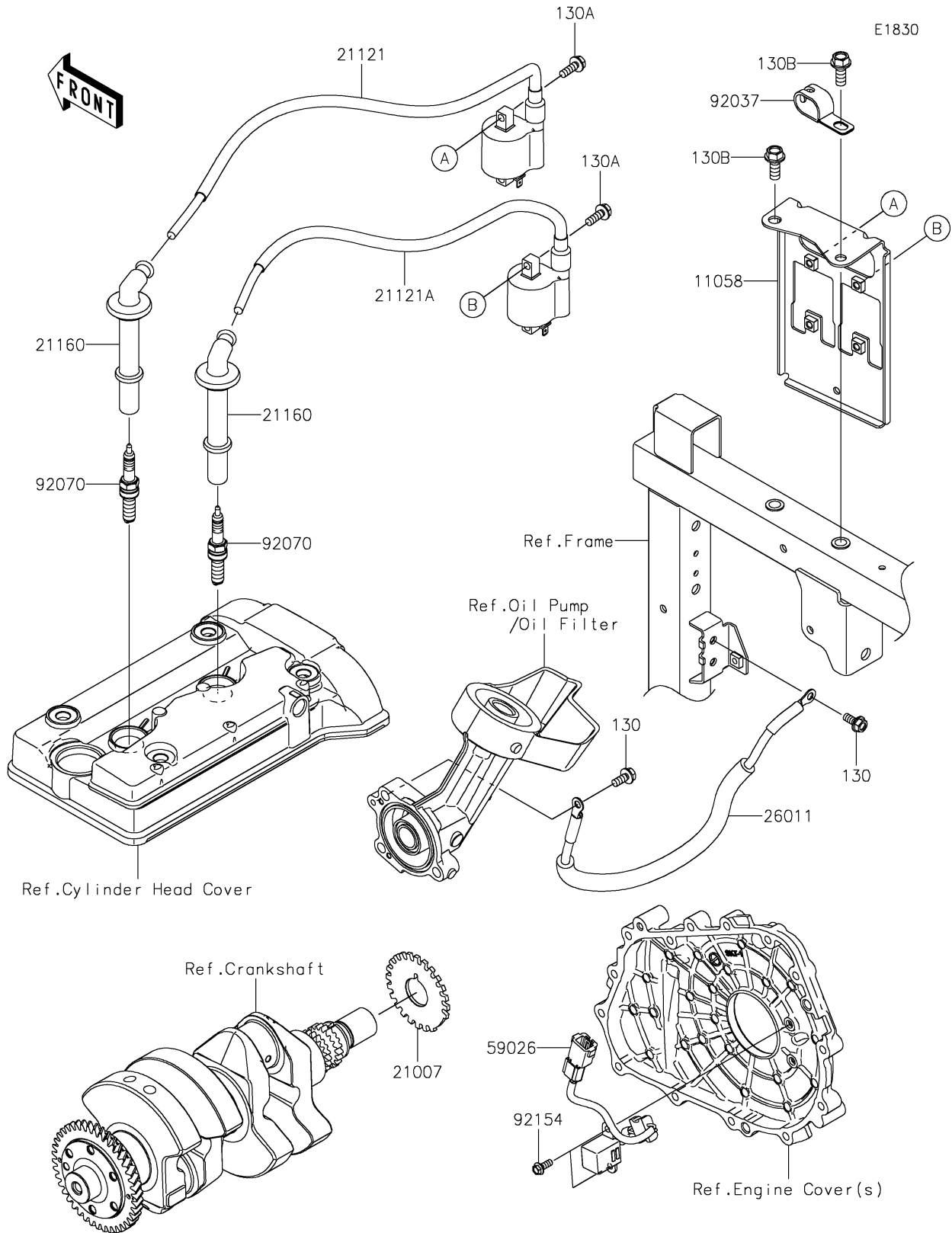

2026 MULE PRO-FXT™ 1000 PLATINUM RANCH EDITION



PARTS LIST Ignition System

ITEM NAME	PART NUMBER	QUANTITY
-----------	-------------	----------
