

2026 MULE PRO-FXT™ 1000 PLATINUM RANCH EDITION

PARTS DIAGRAM Converter Cover

E1393

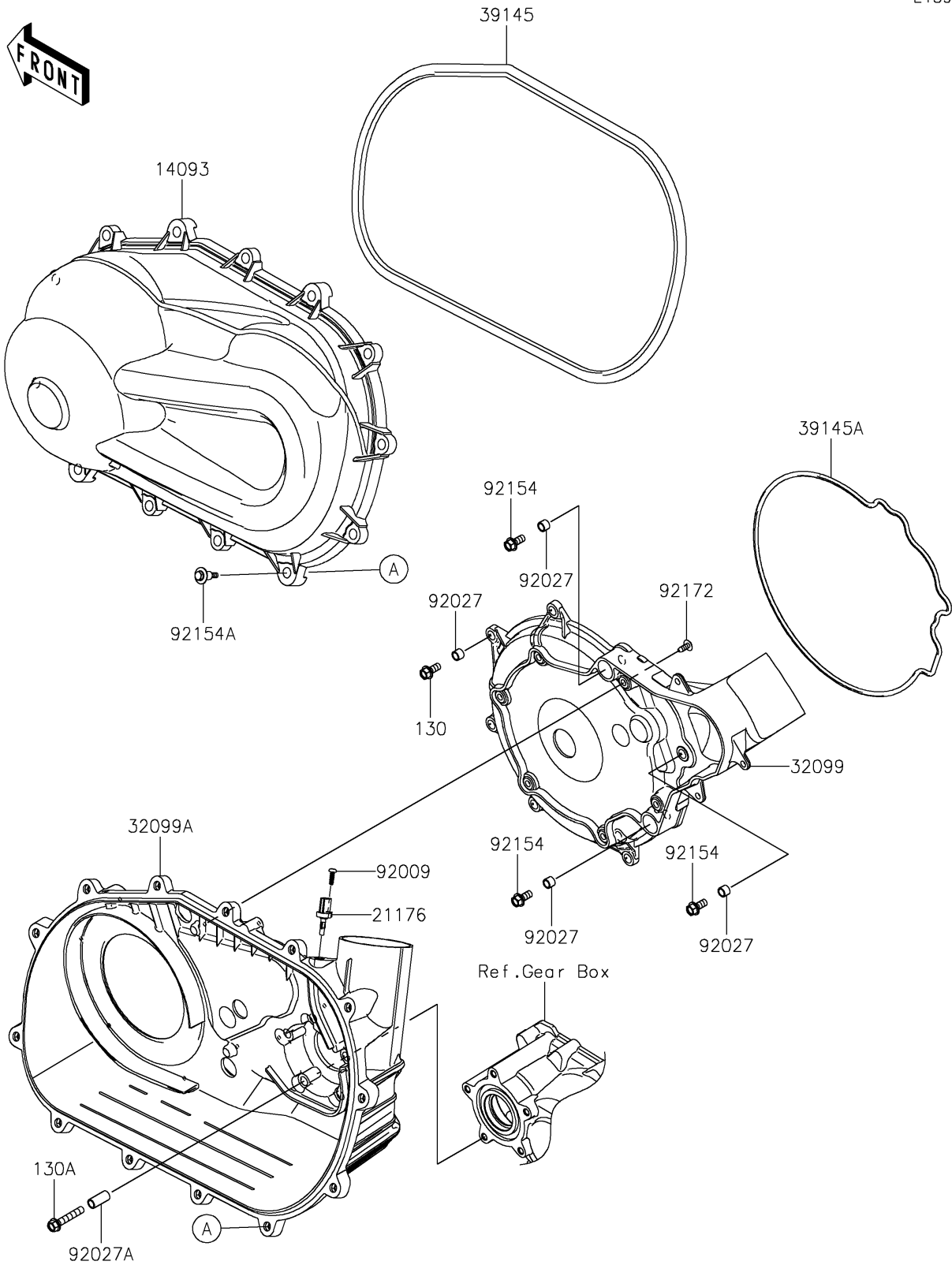

2026 MULE PRO-FXT™ 1000 PLATINUM RANCH EDITION



PARTS LIST Converter Cover

ITEM NAME	PART NUMBER	QUANTITY
-----------	-------------	----------
