

2022 MULE SX™ 4x4 XC LE FI

PARTS DIAGRAM

Optional Parts(Engine)

F2890



(Ref. Drive Converter)

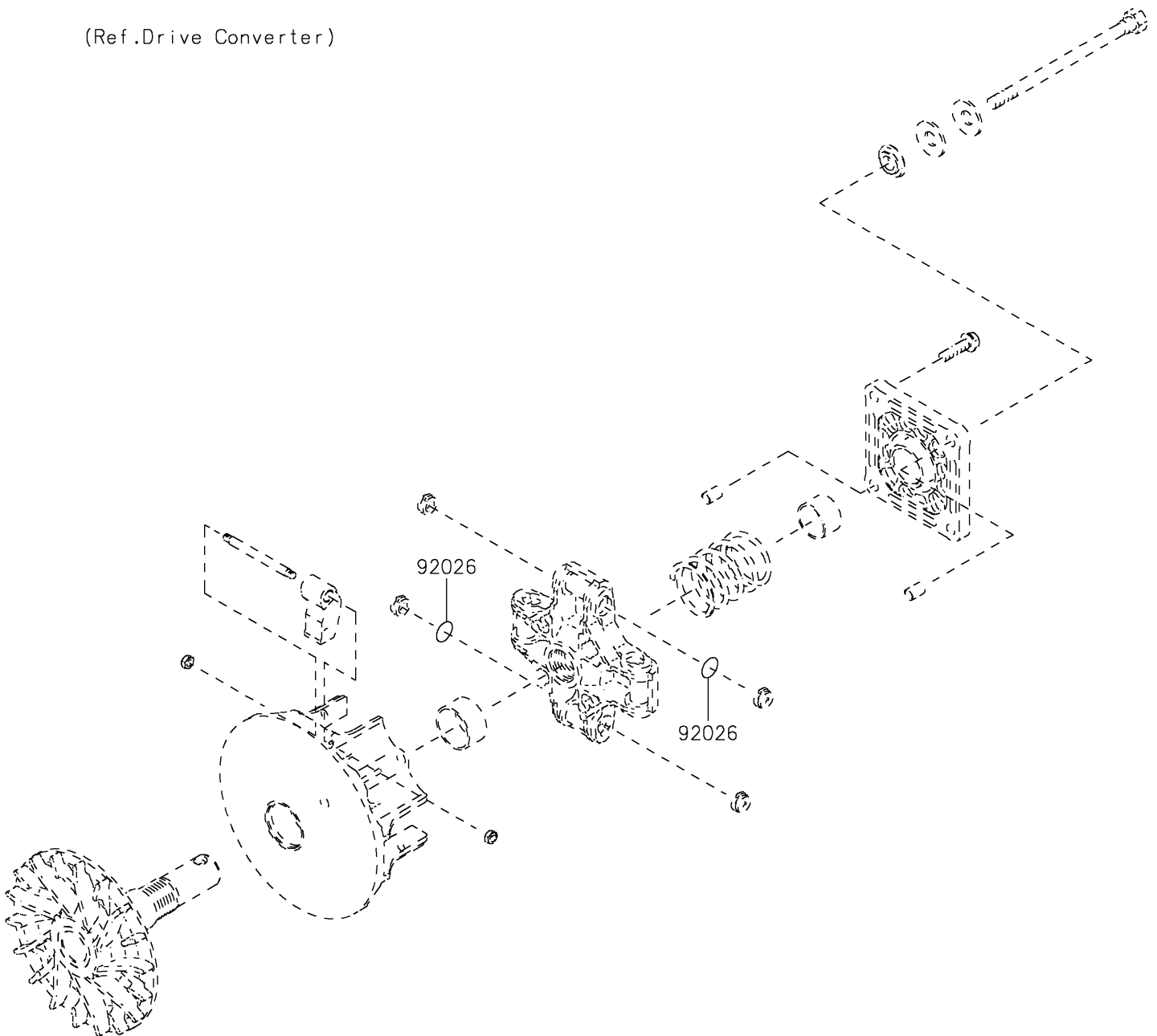

2022 MULE SX™ 4x4 XC LE FI

PARTS LIST

Optional Parts(Engine)

ITEM NAME	PART NUMBER	QUANTITY
-----------	-------------	----------
