

2023 MULE SX™ 4x4 XC LE FI

PARTS DIAGRAM Crankshaft/Piston(s)

E1320

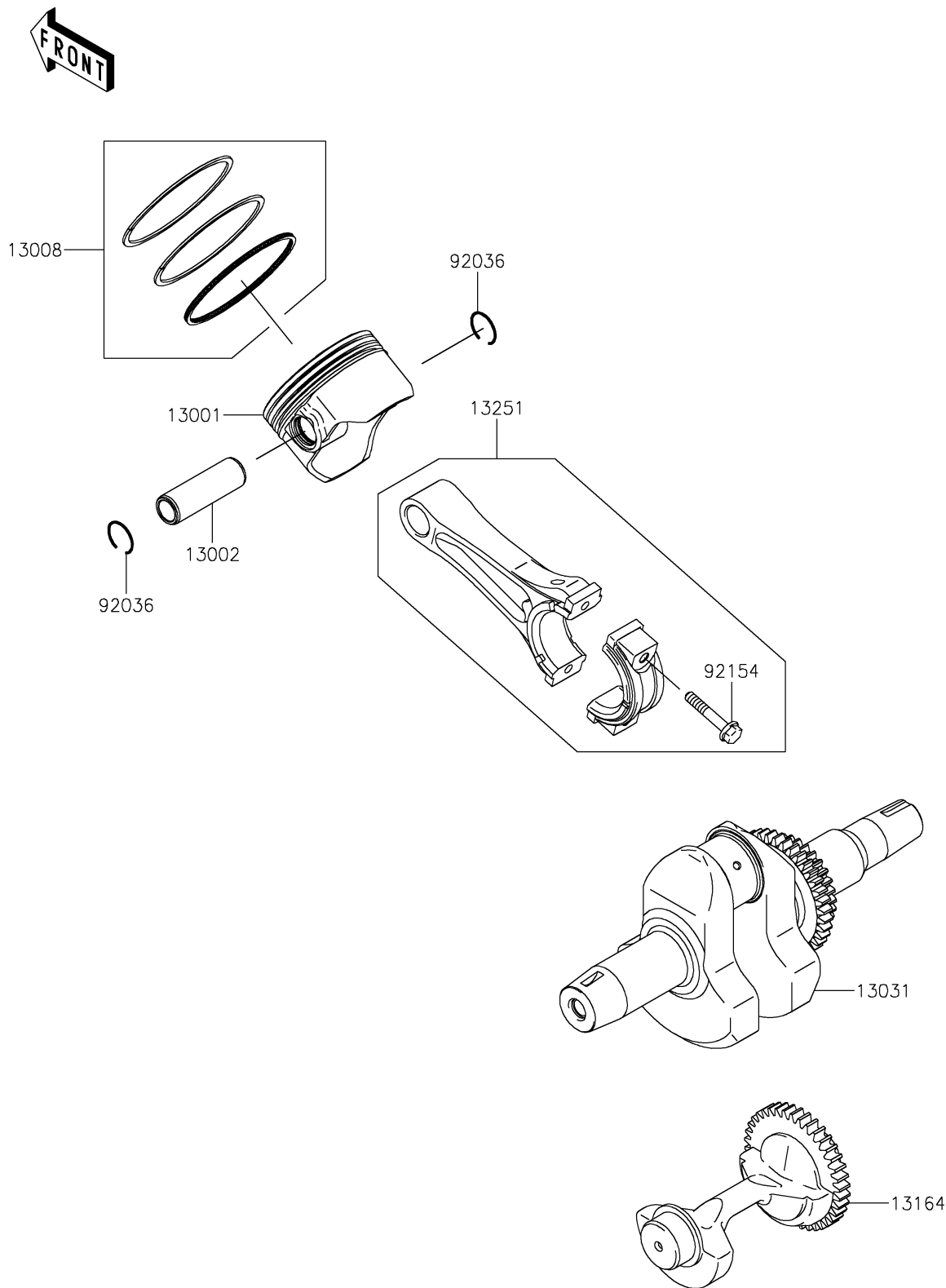

2023 MULE SX™ 4x4 XC LE FI

PARTS LIST

Crankshaft/Piston(s)

ITEM NAME	PART NUMBER	QUANTITY
-----------	-------------	----------
