

2023 MULE SX™ 4x4 XC FI

PARTS DIAGRAM

Front Brake Piping

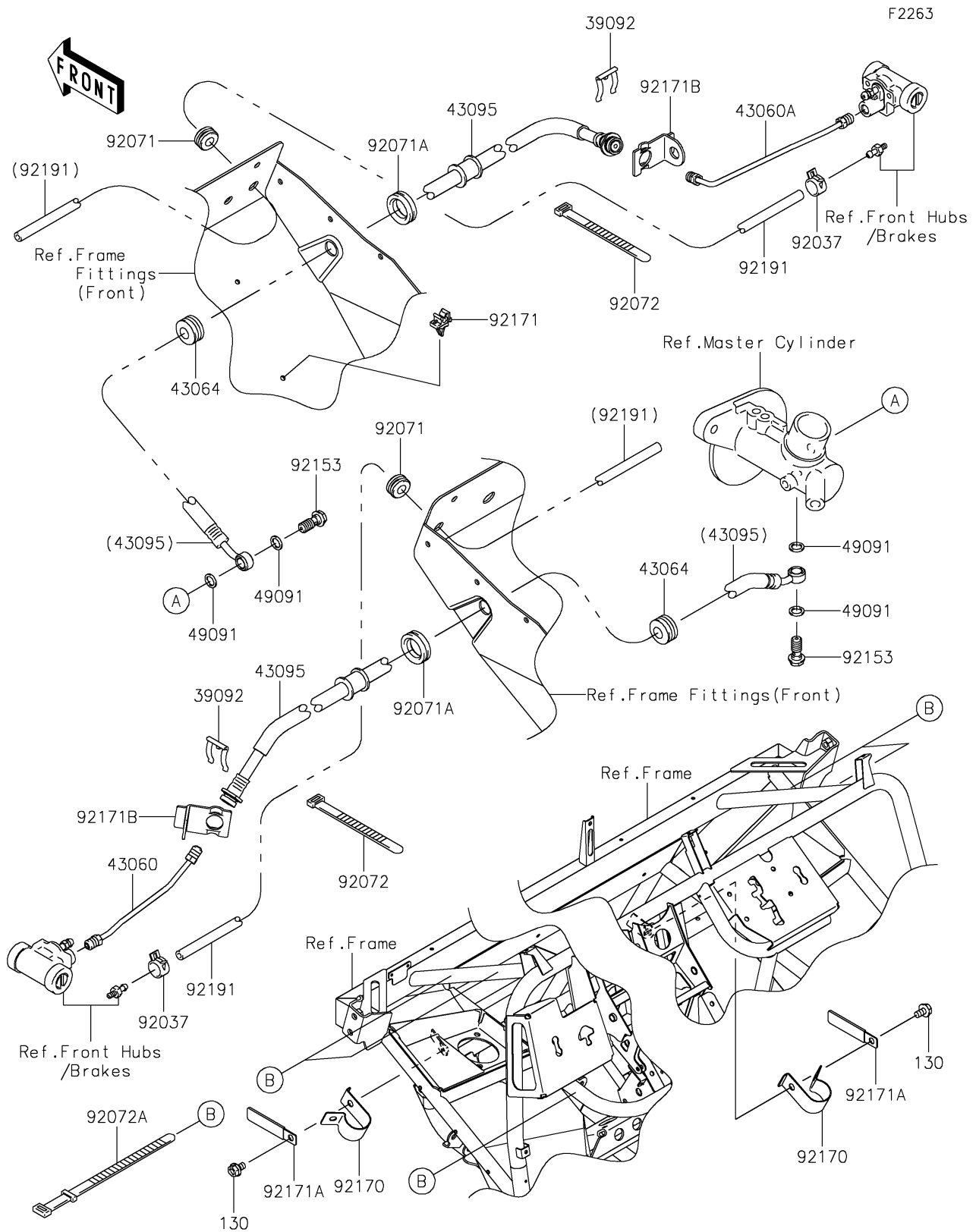

2023 MULE SX™ 4x4 XC FI

PARTS LIST

Front Brake Piping

ITEM NAME	PART NUMBER	QUANTITY
-----------	-------------	----------
