

# 2023 MULE SX™ 4x4 XC FI

## PARTS DIAGRAM

### Crankshaft/Piston(s)

E1320

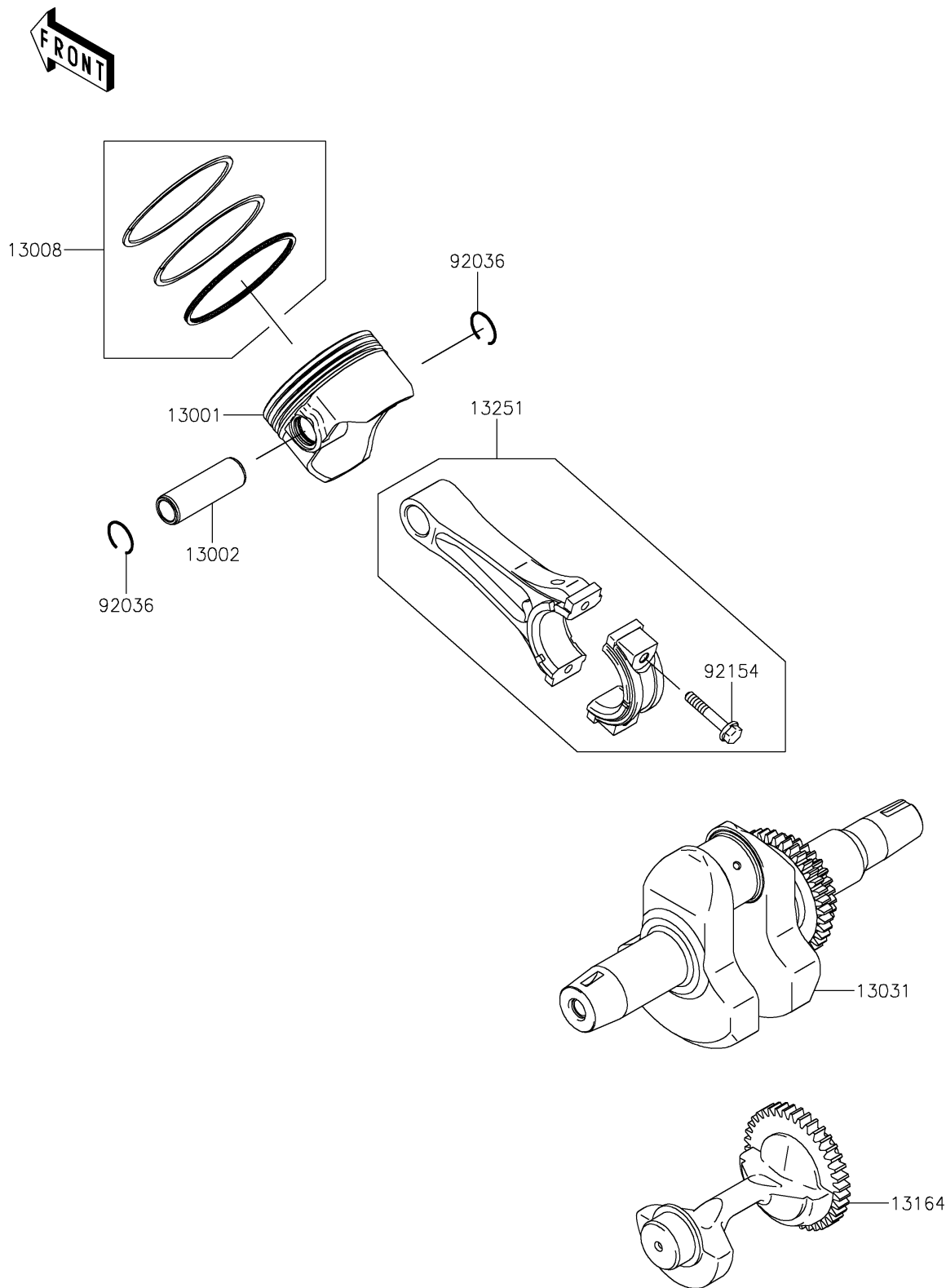

# 2023 MULE SX™ 4x4 XC FI

## PARTS LIST

### Crankshaft/Piston(s)

ITEM NAME	PART NUMBER	QUANTITY
-----------	-------------	----------

---