

# 2023 MULE SX™ 4x4 XC FI

## PARTS DIAGRAM

### Air Cleaner

E1130

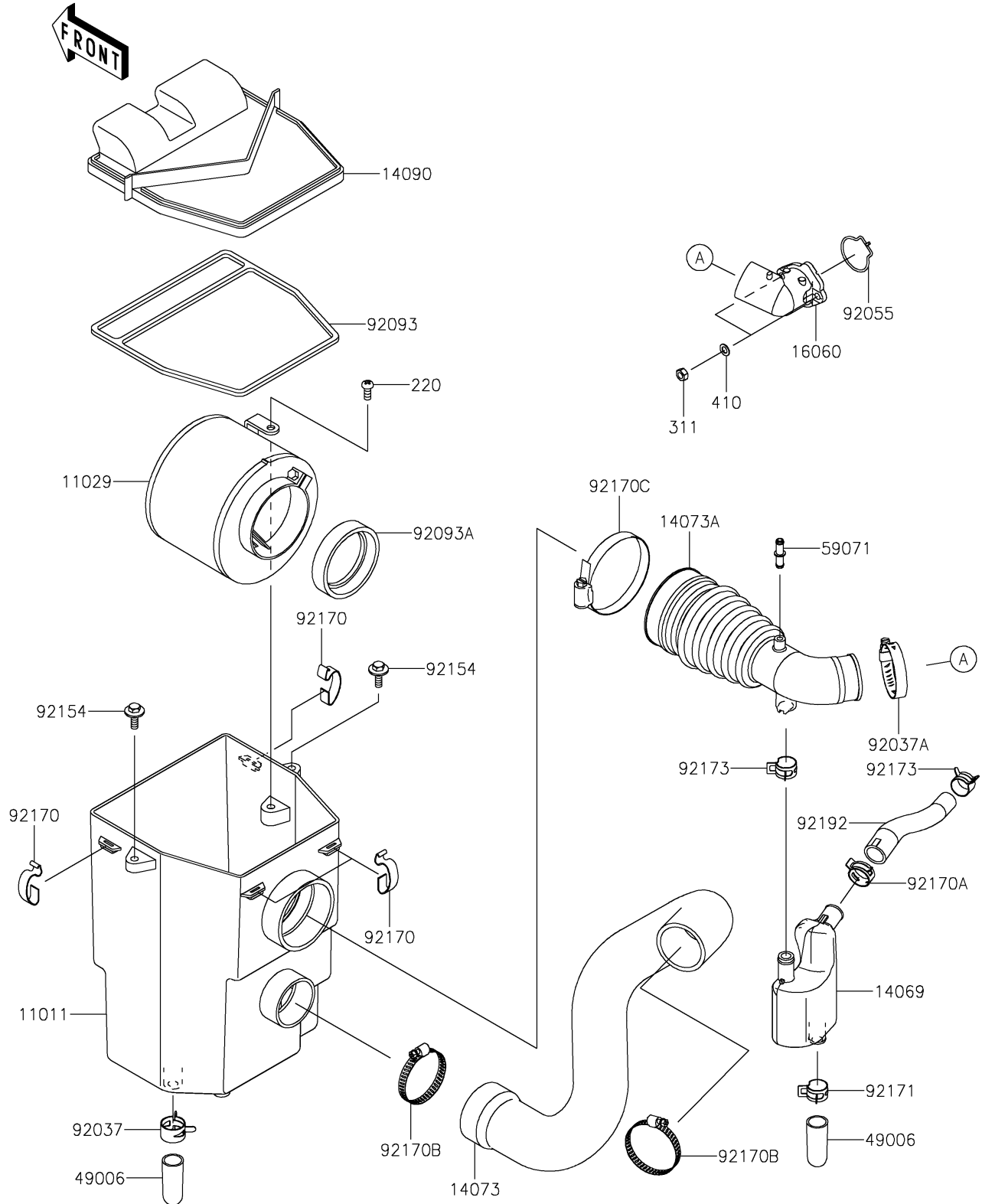

# 2023 MULE SX™ 4x4 XC FI

## PARTS LIST

### Air Cleaner

**ITEM NAME**

**PART NUMBER**

**QUANTITY**

---