

# 2022 MULE SX™ 4x4 FI

## PARTS DIAGRAM

### Swingarm

F2141

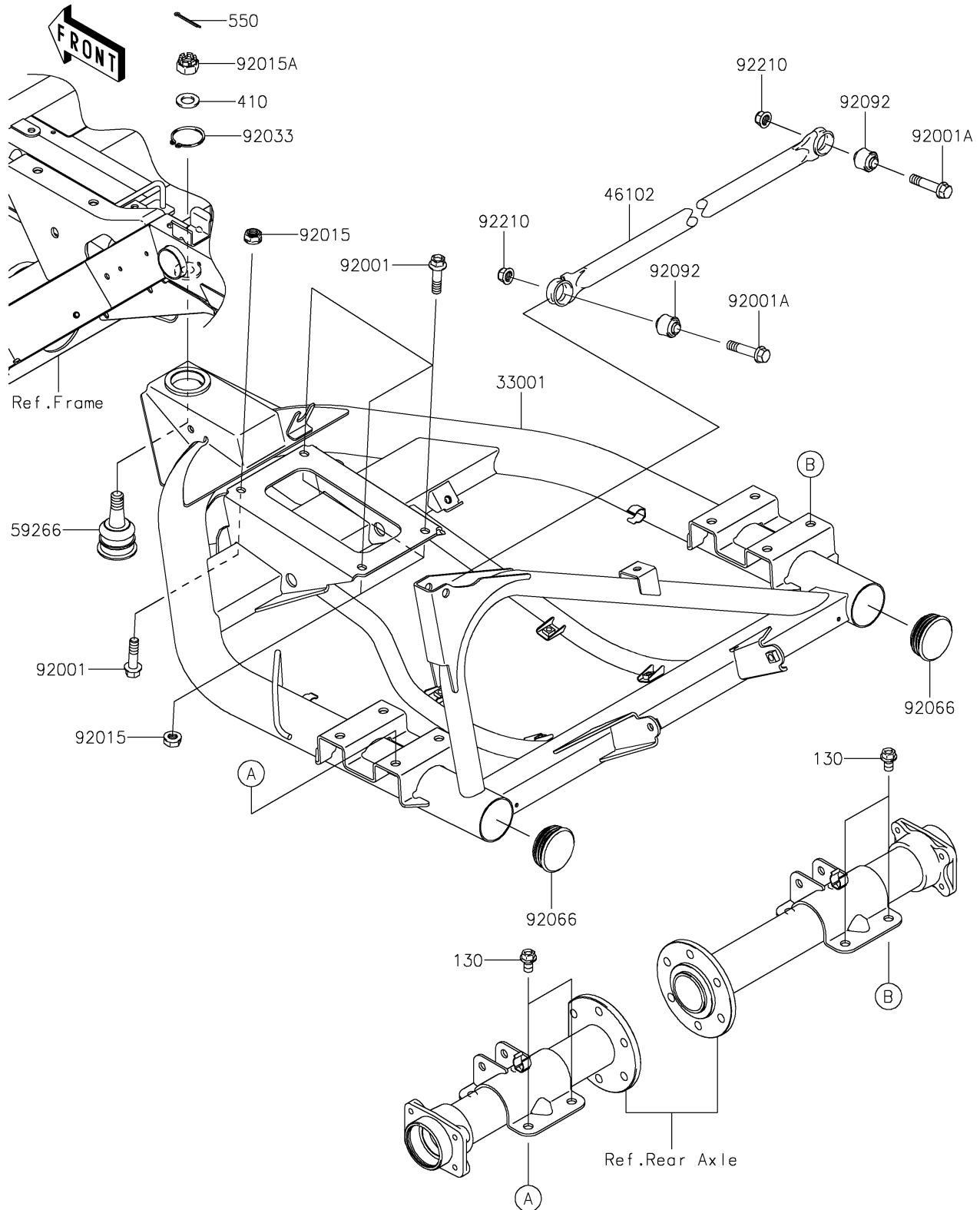

# 2022 MULE SX™ 4x4 FI

## PARTS LIST

### Swingarm

**ITEM NAME**

**PART NUMBER**

**QUANTITY**

---