

# 2021 MULE SX™ 4x4 FI

## PARTS DIAGRAM

### Engine Mount

F2122

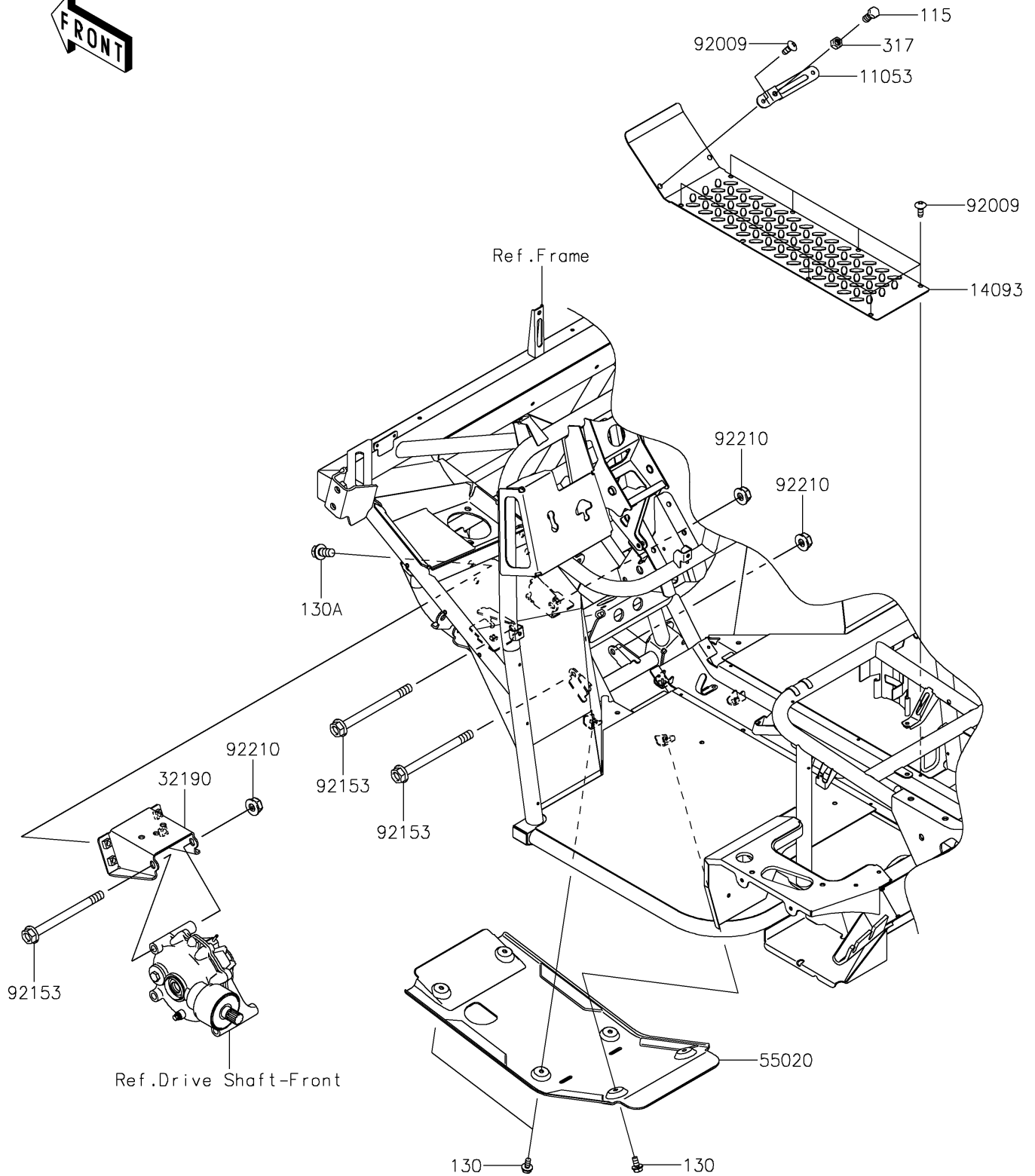

# 2021 MULE SX™ 4x4 FI

## PARTS LIST

### Engine Mount

ITEM NAME	PART NUMBER	QUANTITY
-----------	-------------	----------

---