

# 2021 MULE SX™ 4x4 FI

## PARTS DIAGRAM

### Drive Converter

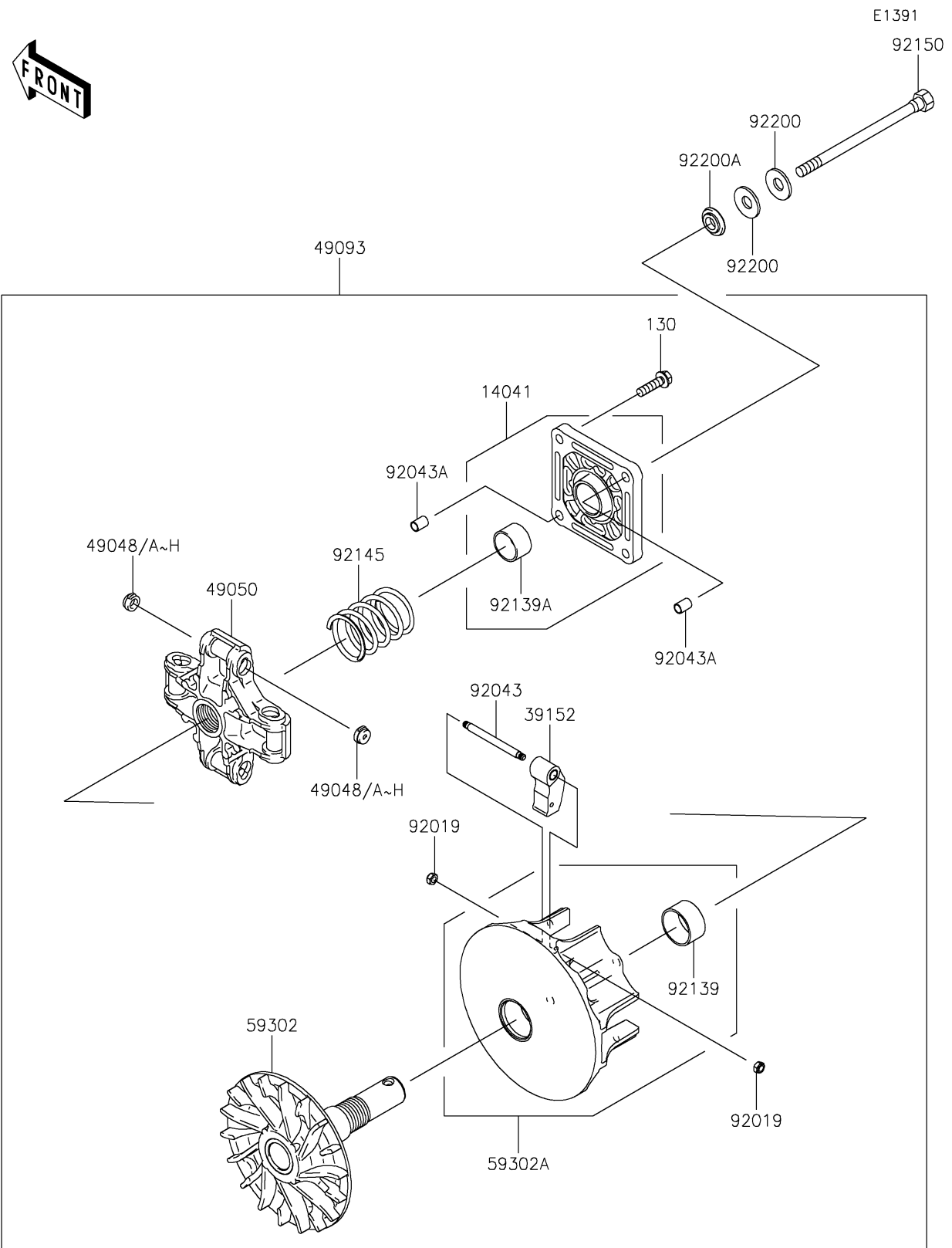

# 2021 MULE SX™ 4x4 FI

## PARTS LIST

### Drive Converter

**ITEM NAME**

**PART NUMBER**

**QUANTITY**

---