

2021 MULE SX™ 4x4 FI

PARTS DIAGRAM Crankshaft/Piston(s)

E1320

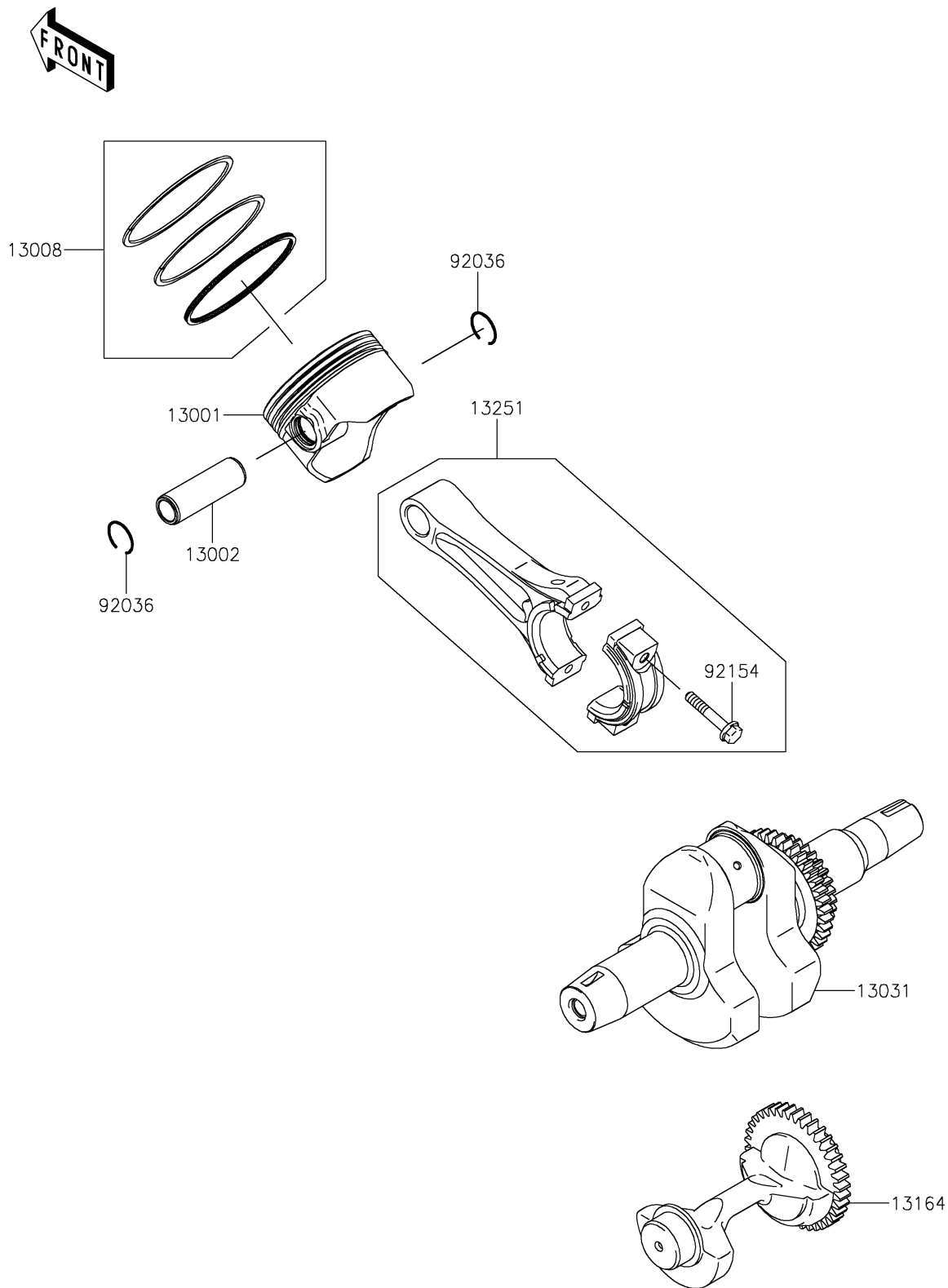

2021 MULE SX™ 4x4 FI

PARTS LIST

Crankshaft/Piston(s)

ITEM NAME

PART NUMBER

QUANTITY
