

# 2020 BRUTE FORCE® 750 4x4i EPS

## PARTS DIAGRAM

### Owner's Tools

F2810

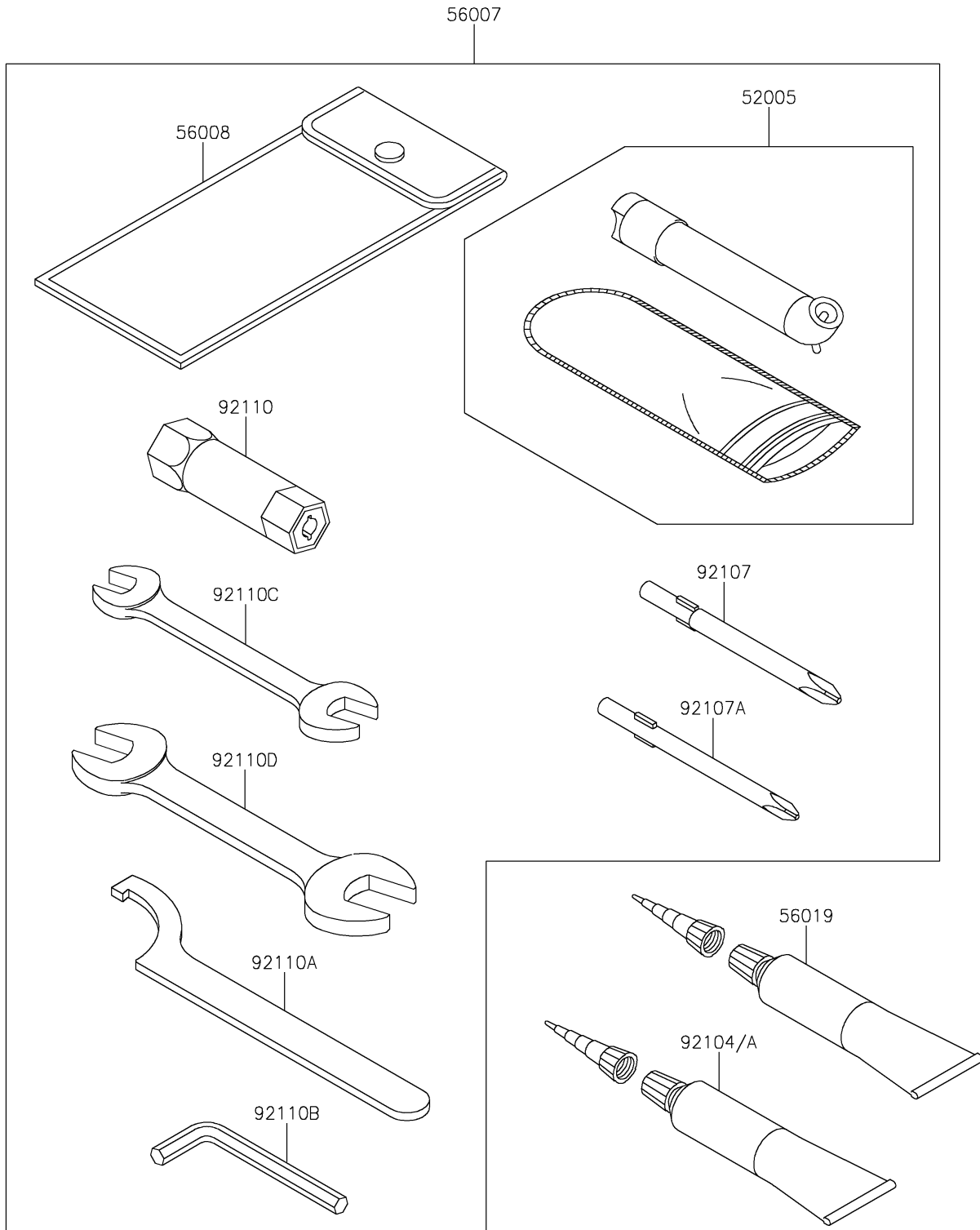

# 2020 BRUTE FORCE® 750 4x4i EPS



## PARTS LIST Owner's Tools

ITEM NAME	PART NUMBER	QUANTITY
-----------	-------------	----------

---