

# 2019 MULE SX™ 4x4 XC LE FI

## PARTS DIAGRAM

Other

F2750

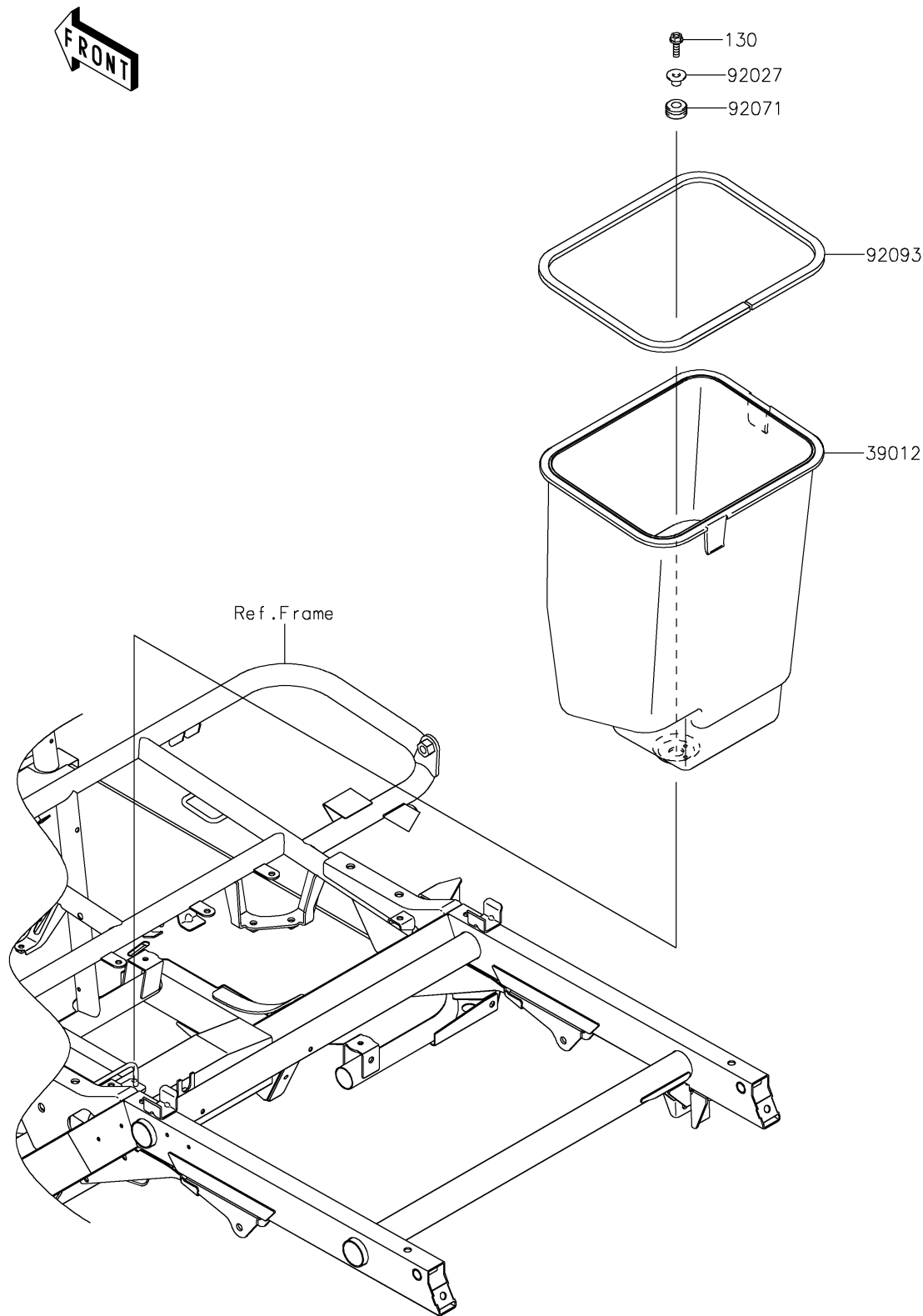

# 2019 MULE SX™ 4x4 XC LE FI

## PARTS LIST

Other

**ITEM NAME**

**PART NUMBER**

**QUANTITY**

---