

# 2020 MULE SX™ 4x4 XC FI

## PARTS DIAGRAM

### Swingarm

F2141

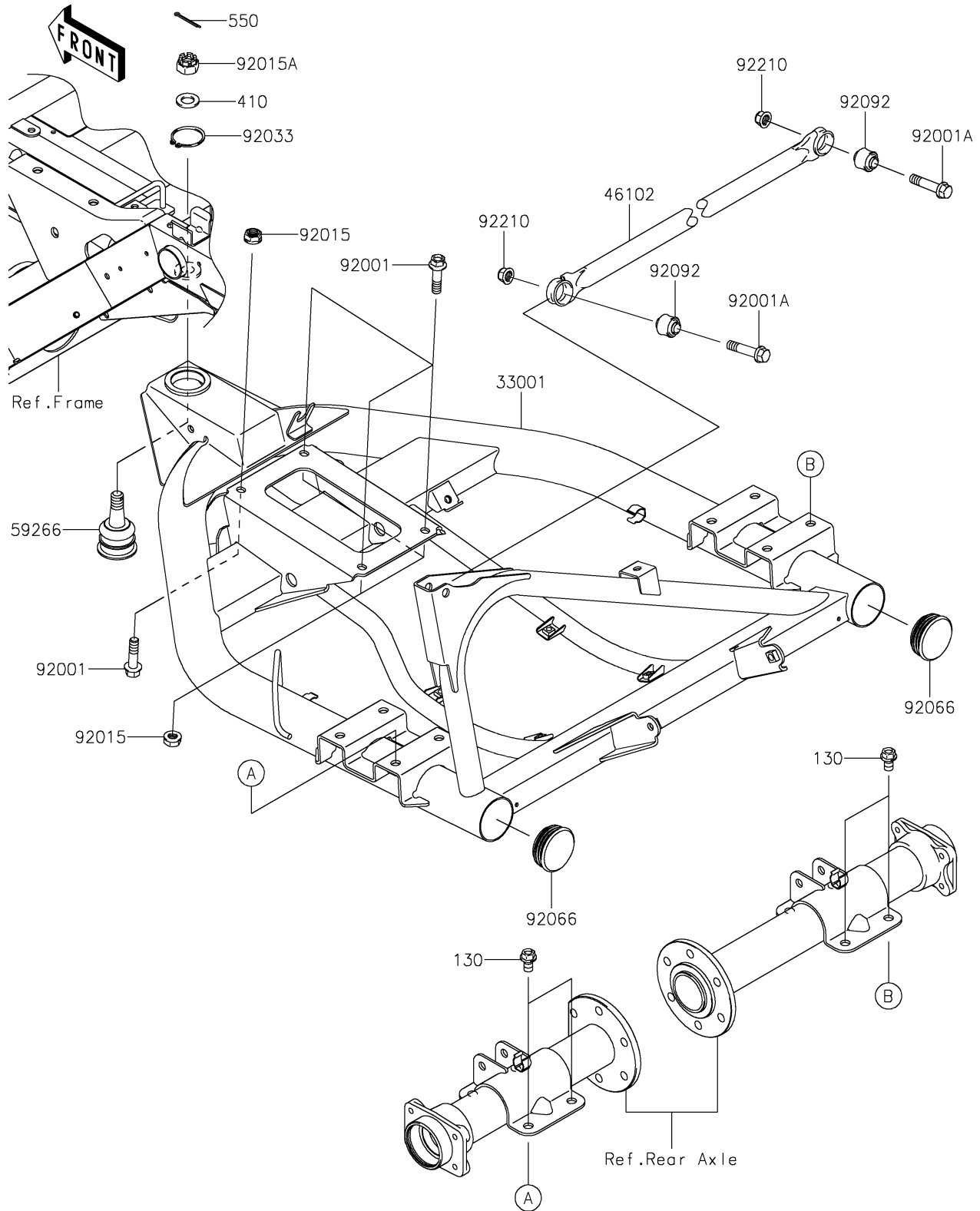

# 2020 MULE SX™ 4x4 XC FI

## PARTS LIST

### Swingarm

**ITEM NAME**

**PART NUMBER**

**QUANTITY**

---