

# 2020 MULE SX™ 4x4 FI

## PARTS DIAGRAM

### Labels

F2860

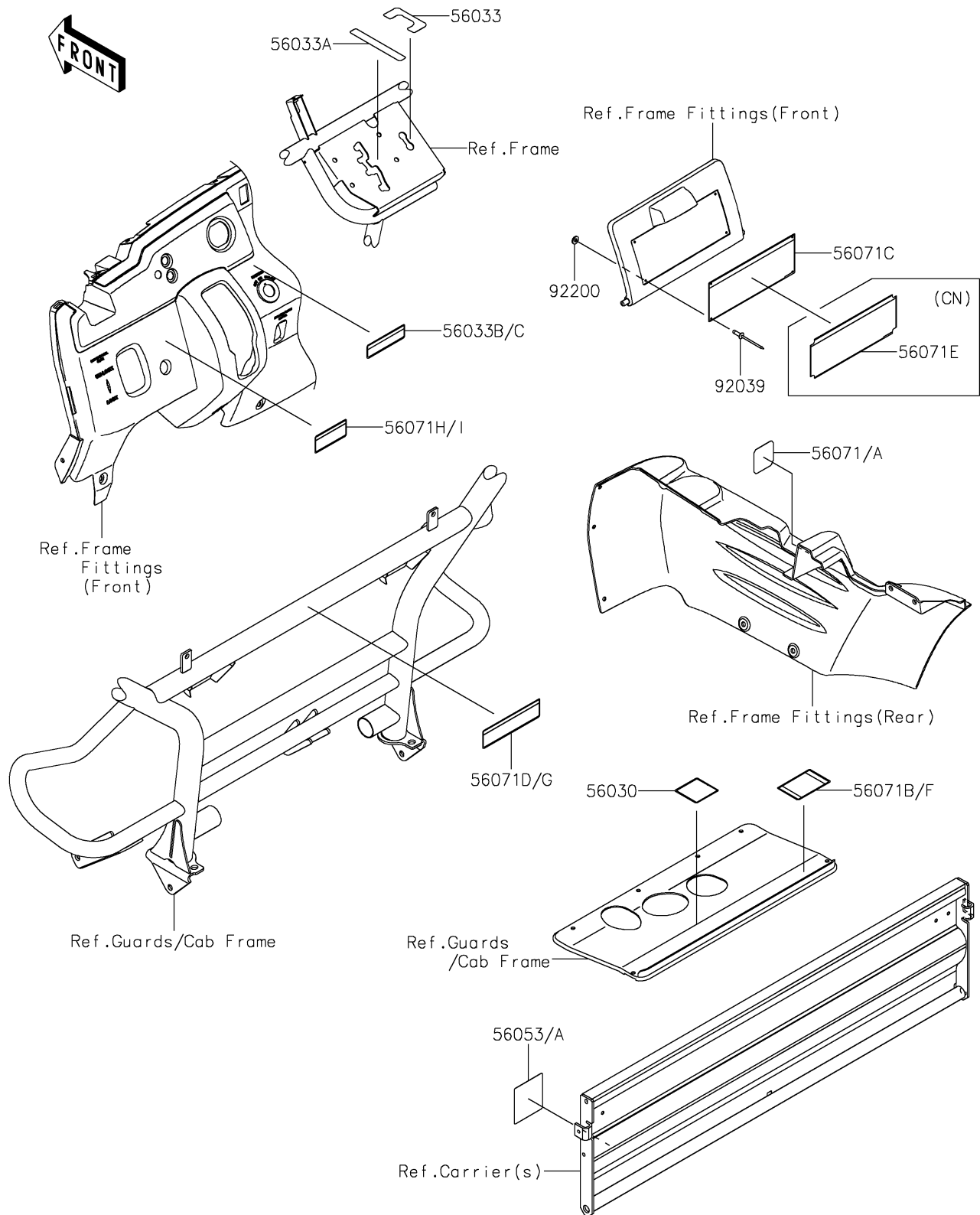

# 2020 MULE SX™ 4x4 FI

## PARTS LIST

### Labels

**ITEM NAME**

**PART NUMBER**

**QUANTITY**

---