

# 2024 JET SKI® ULTRA® 310LX

## PARTS DIAGRAM

### Throttle

E1510

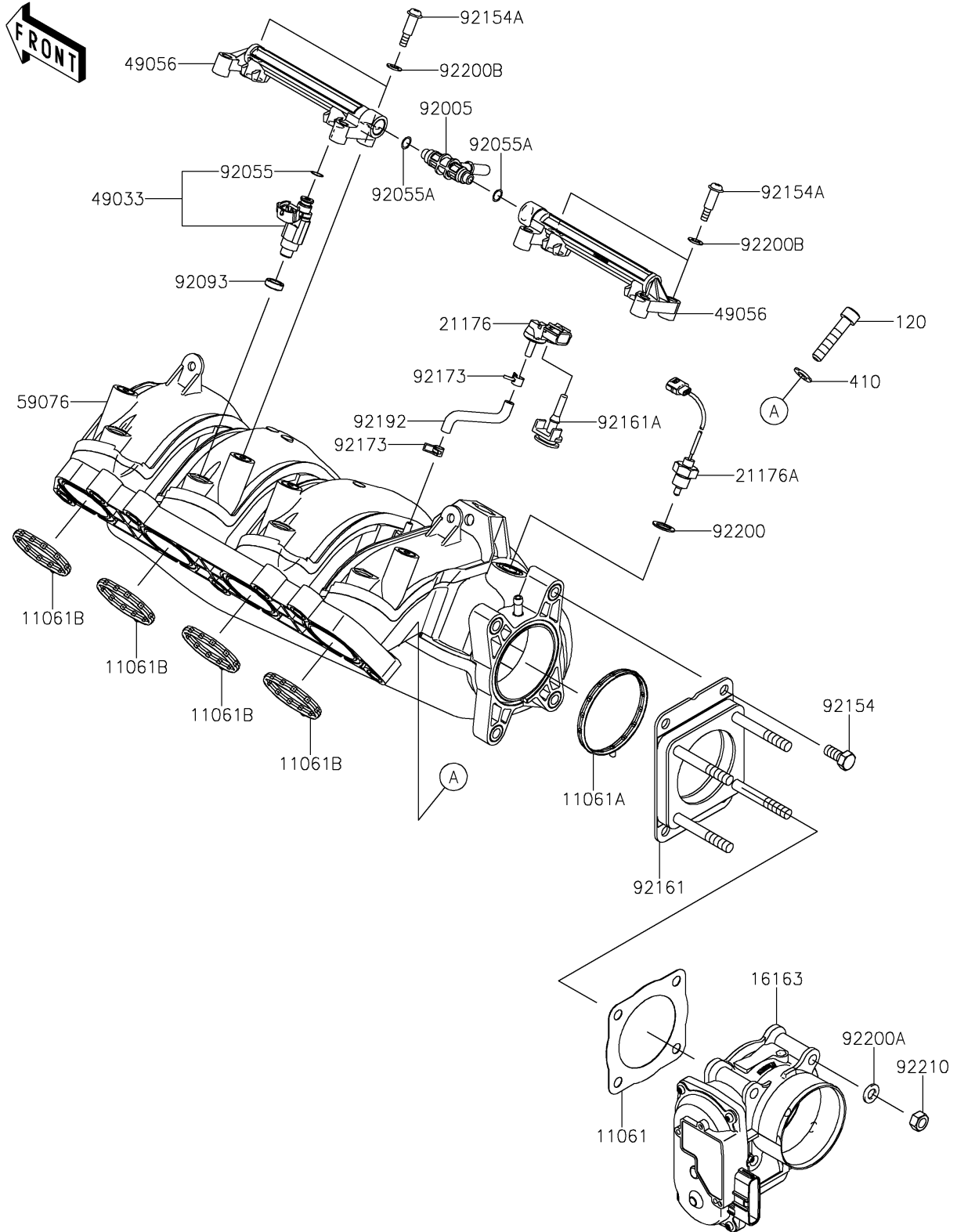

# 2024 JET SKI® ULTRA® 310LX

## PARTS LIST

### Throttle

**ITEM NAME**

**PART NUMBER**

**QUANTITY**

---