

2025 NINJA H2[®] CARBON ABS

PARTS DIAGRAM

Seat

F2510

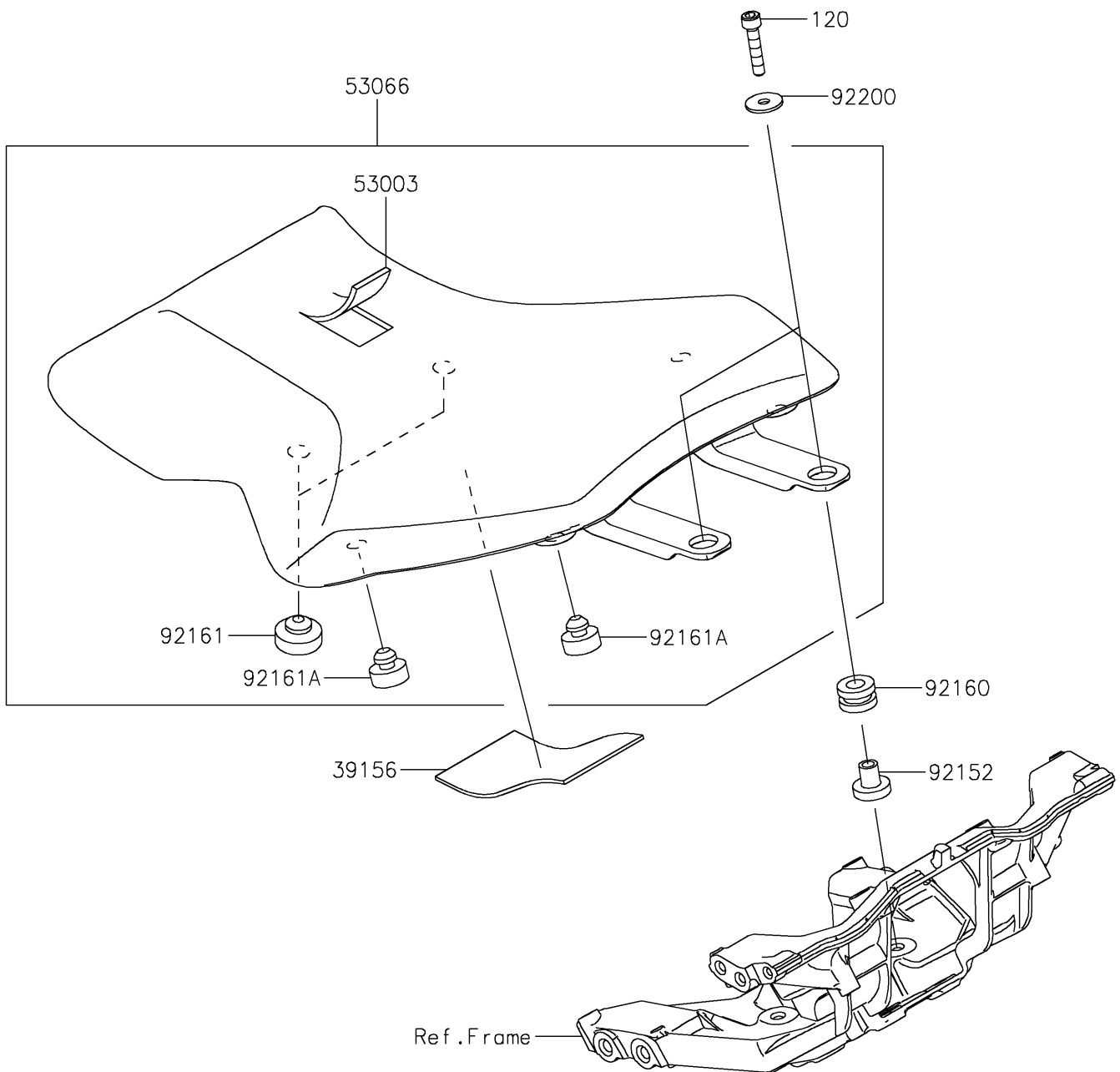

2025 NINJA H2[®] CARBON ABS

PARTS LIST

Seat

ITEM NAME	PART NUMBER	QUANTITY
-----------	-------------	----------
