

2025 NINJA H2[®] CARBON ABS

PARTS DIAGRAM

Handlebar

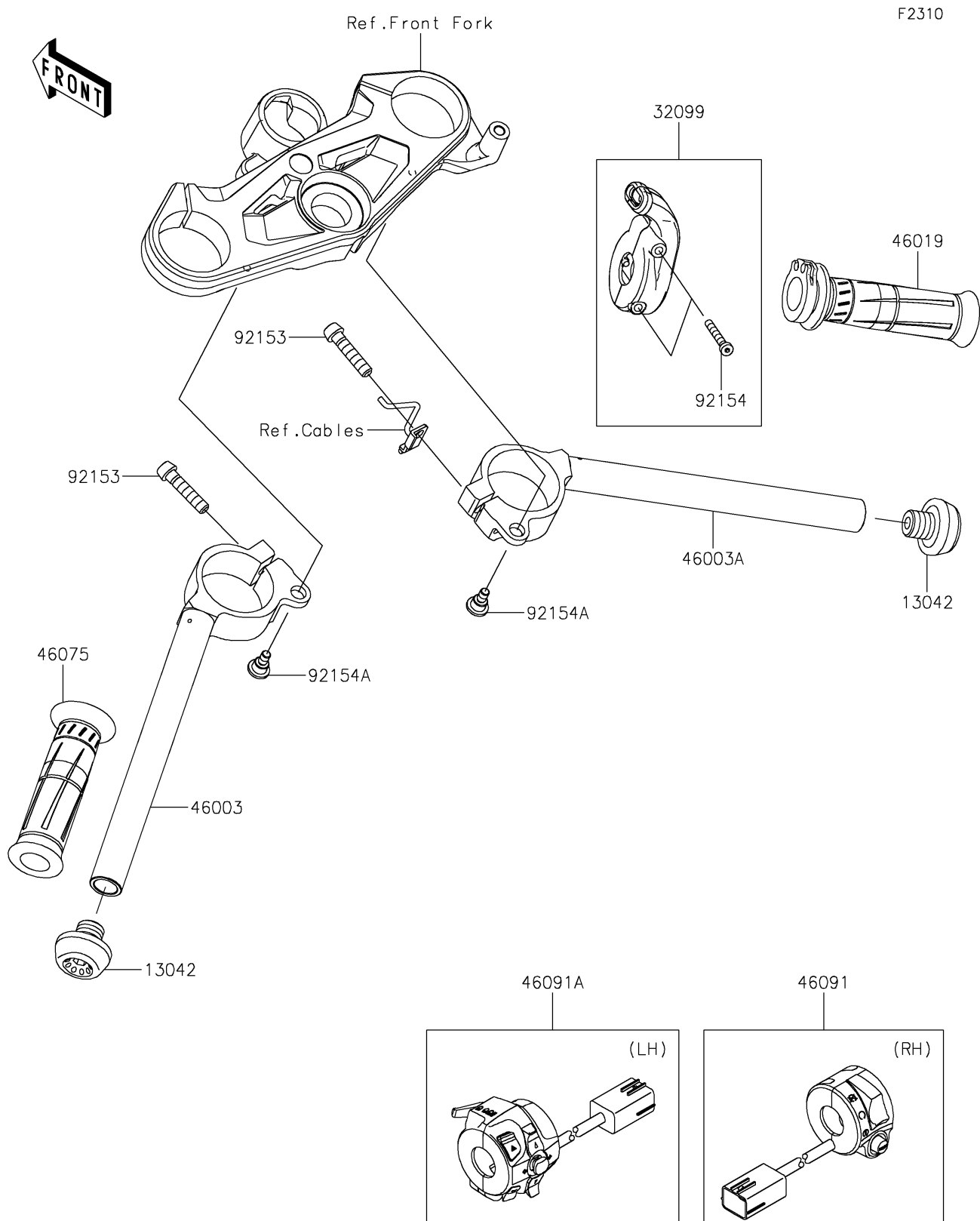

2025 NINJA H2[®] CARBON ABS

PARTS LIST

Handlebar

ITEM NAME	PART NUMBER	QUANTITY
-----------	-------------	----------
