

2025 NINJA H2[®] CARBON ABS

PARTS DIAGRAM

Fuel Injection

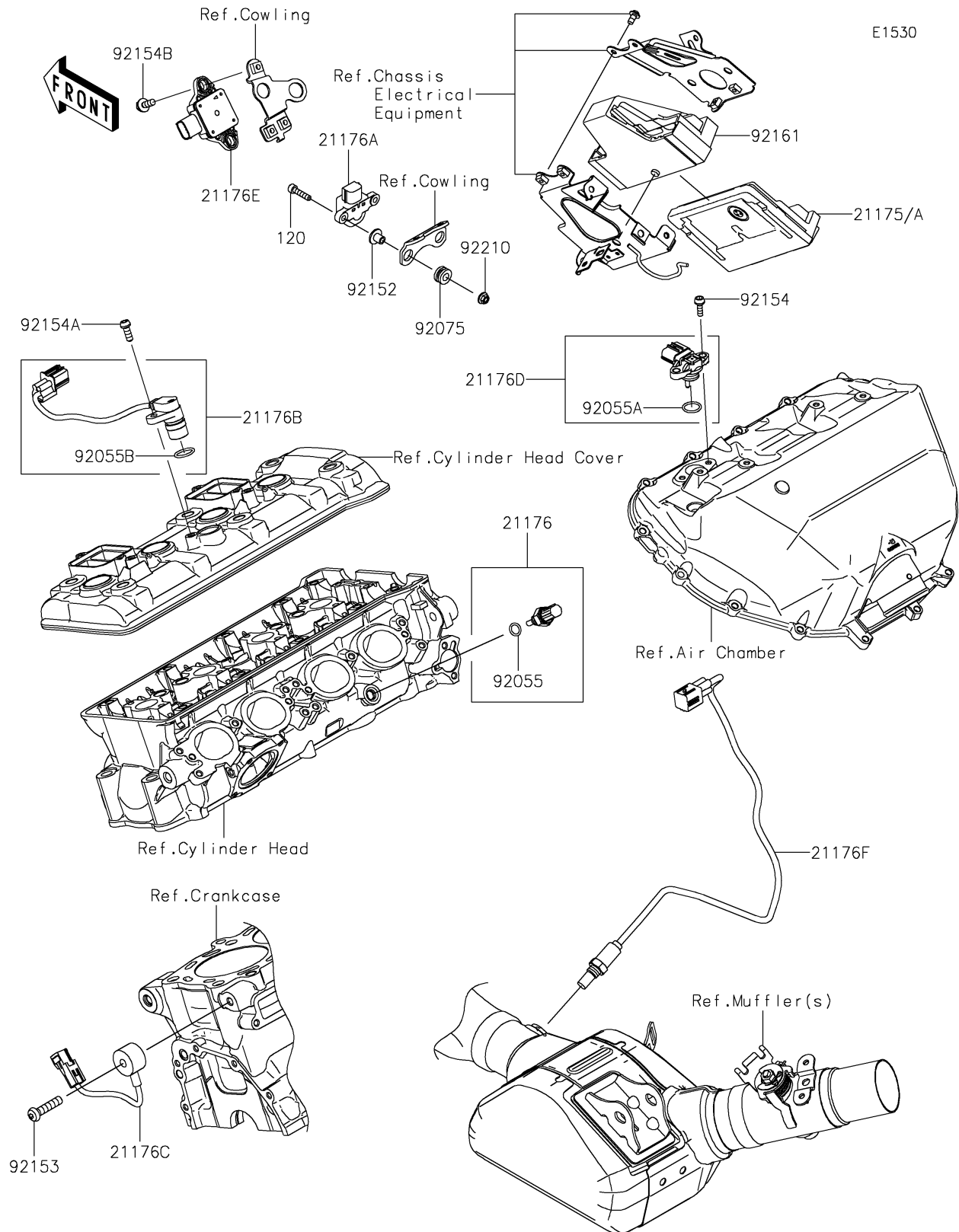

2025 NINJA H2[®] CARBON ABS

PARTS LIST

Fuel Injection

ITEM NAME	PART NUMBER	QUANTITY
-----------	-------------	----------
