

2025 NINJA H2[®] CARBON ABS

PARTS DIAGRAM

Crankcase

E1411

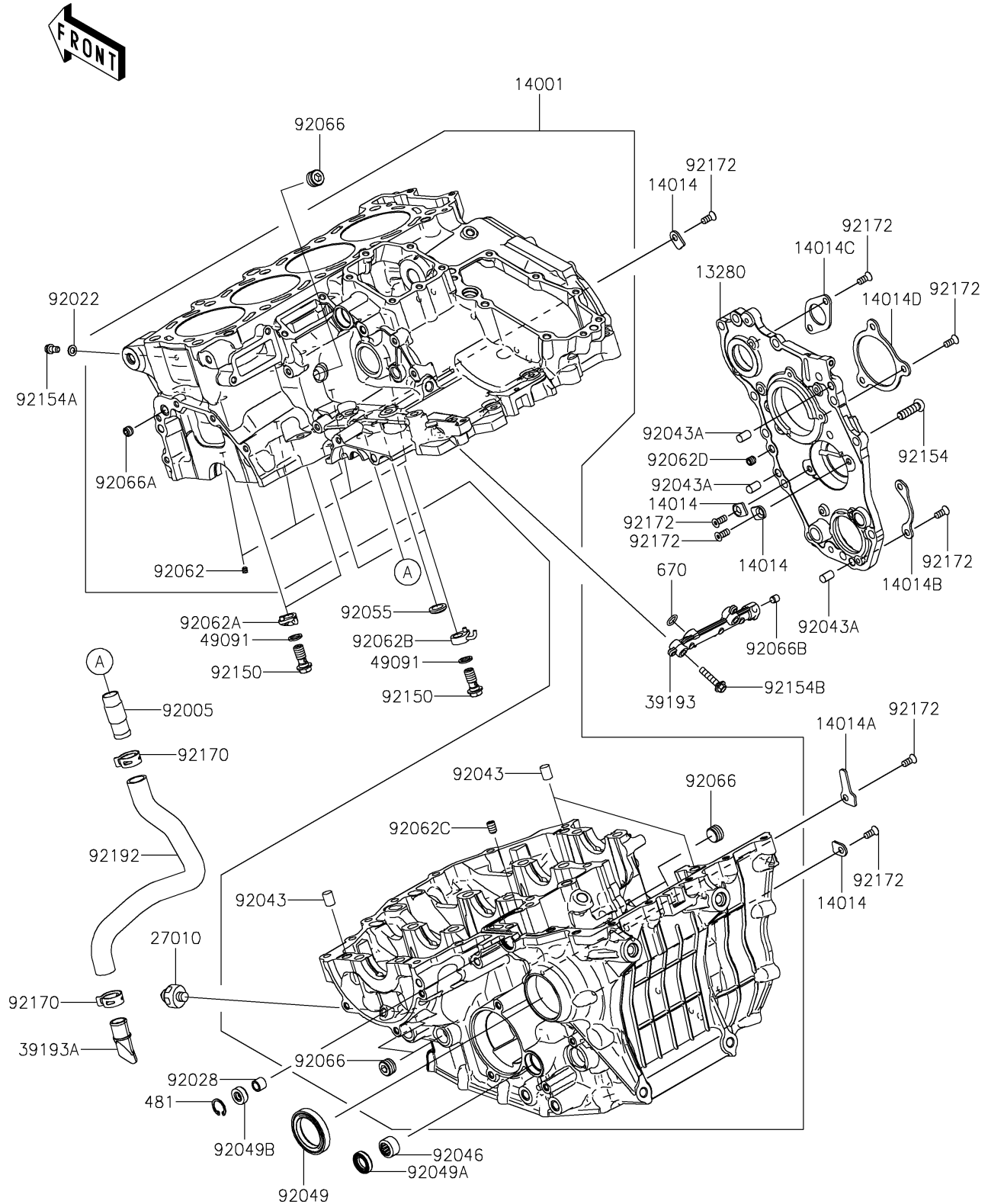

2025 NINJA H2[®] CARBON ABS

PARTS LIST

Crankcase

ITEM NAME	PART NUMBER	QUANTITY
-----------	-------------	----------
