

2025 NINJA H2[®] CARBON ABS

PARTS DIAGRAM

Transmission

E1361

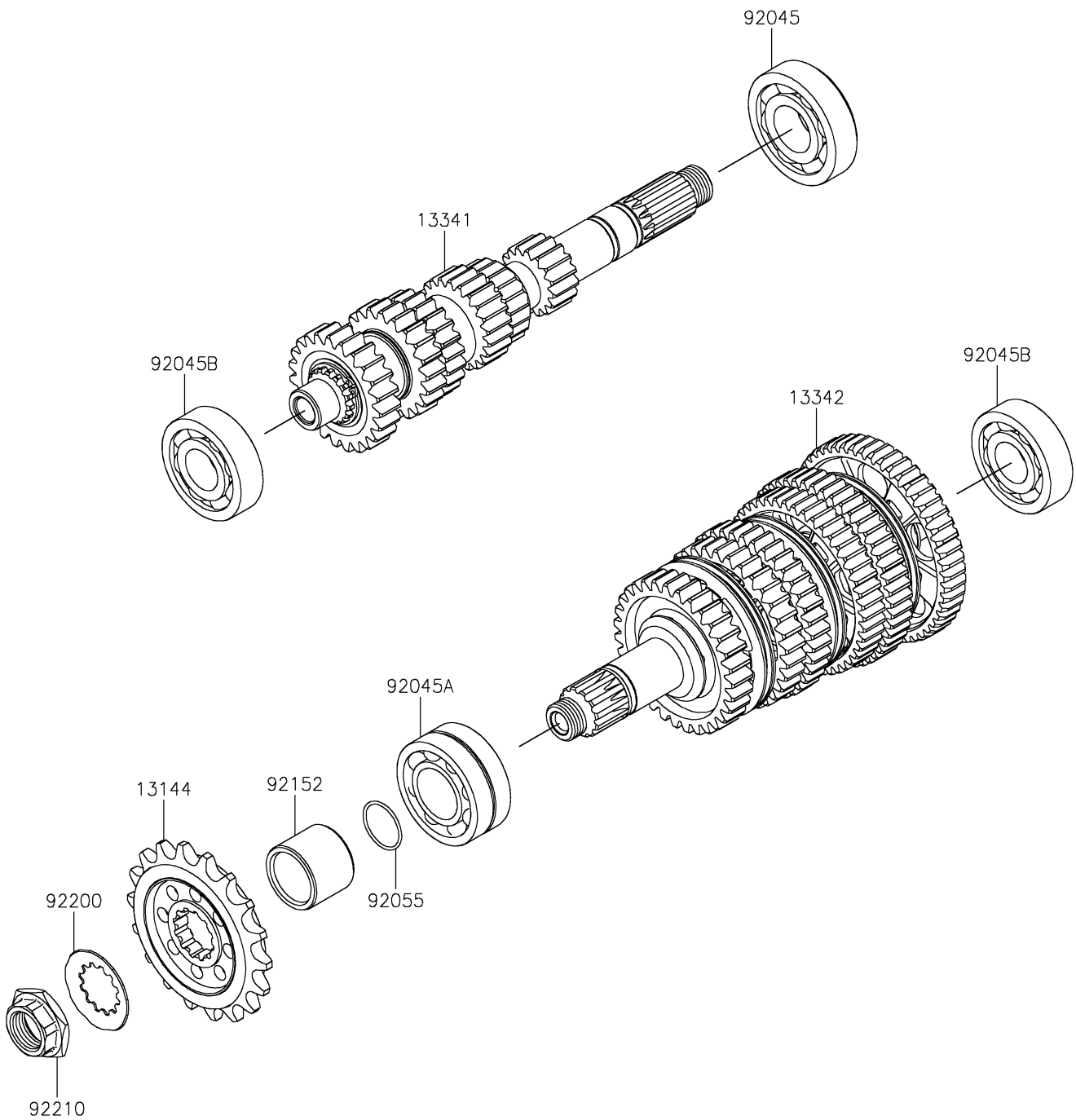

2025 NINJA H2[®] CARBON ABS

PARTS LIST

Transmission

ITEM NAME	PART NUMBER	QUANTITY
-----------	-------------	----------
