

2025 NINJA H2[®] CARBON ABS

PARTS DIAGRAM

Air Cleaner

E1130

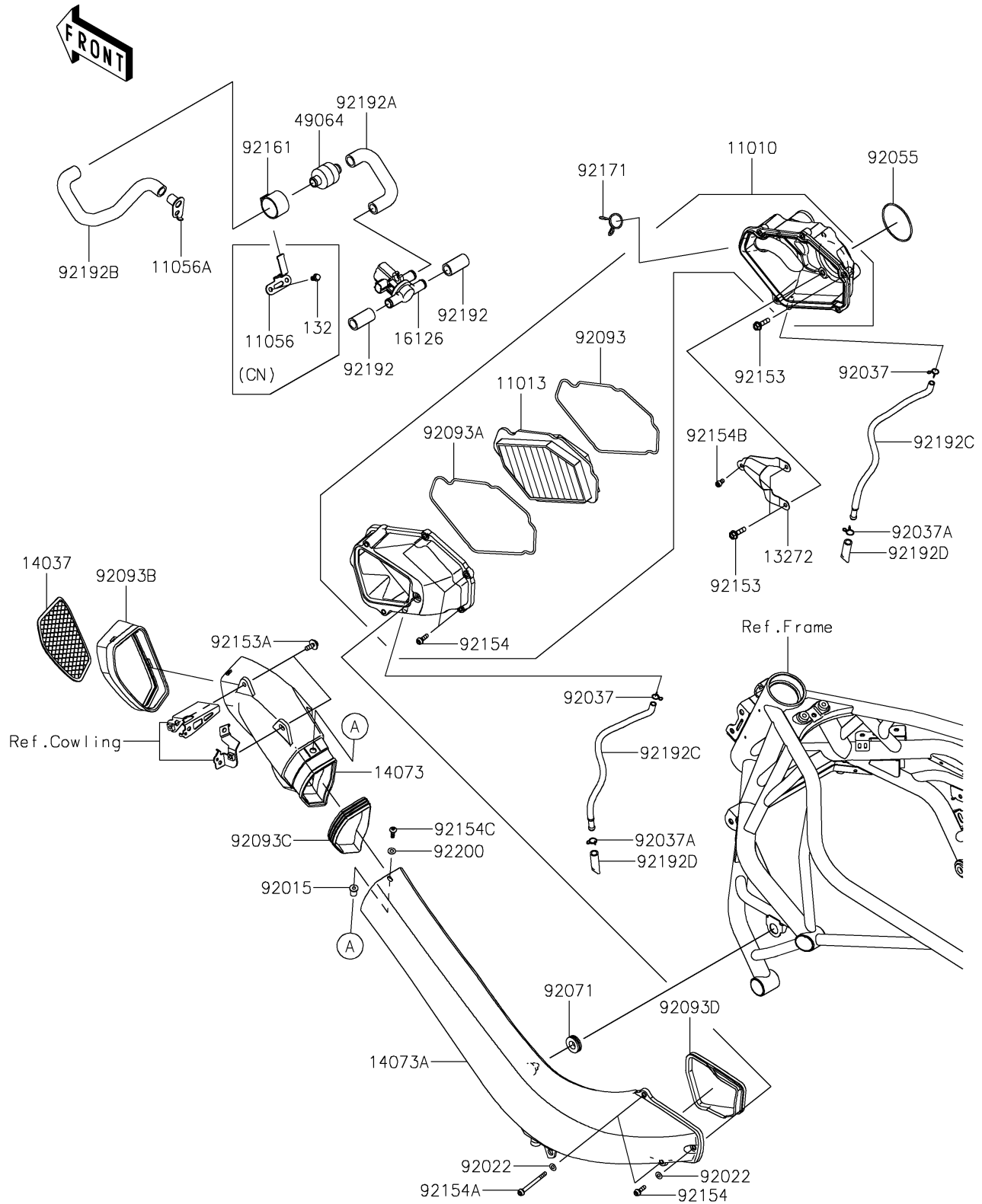

2025 NINJA H2[®] CARBON ABS

PARTS LIST

Air Cleaner

ITEM NAME	PART NUMBER	QUANTITY
-----------	-------------	----------
