

# 2024 Ninja ZX-14R ABS SE

## PARTS DIAGRAM

### Side Covers/Chain Cover

F2610

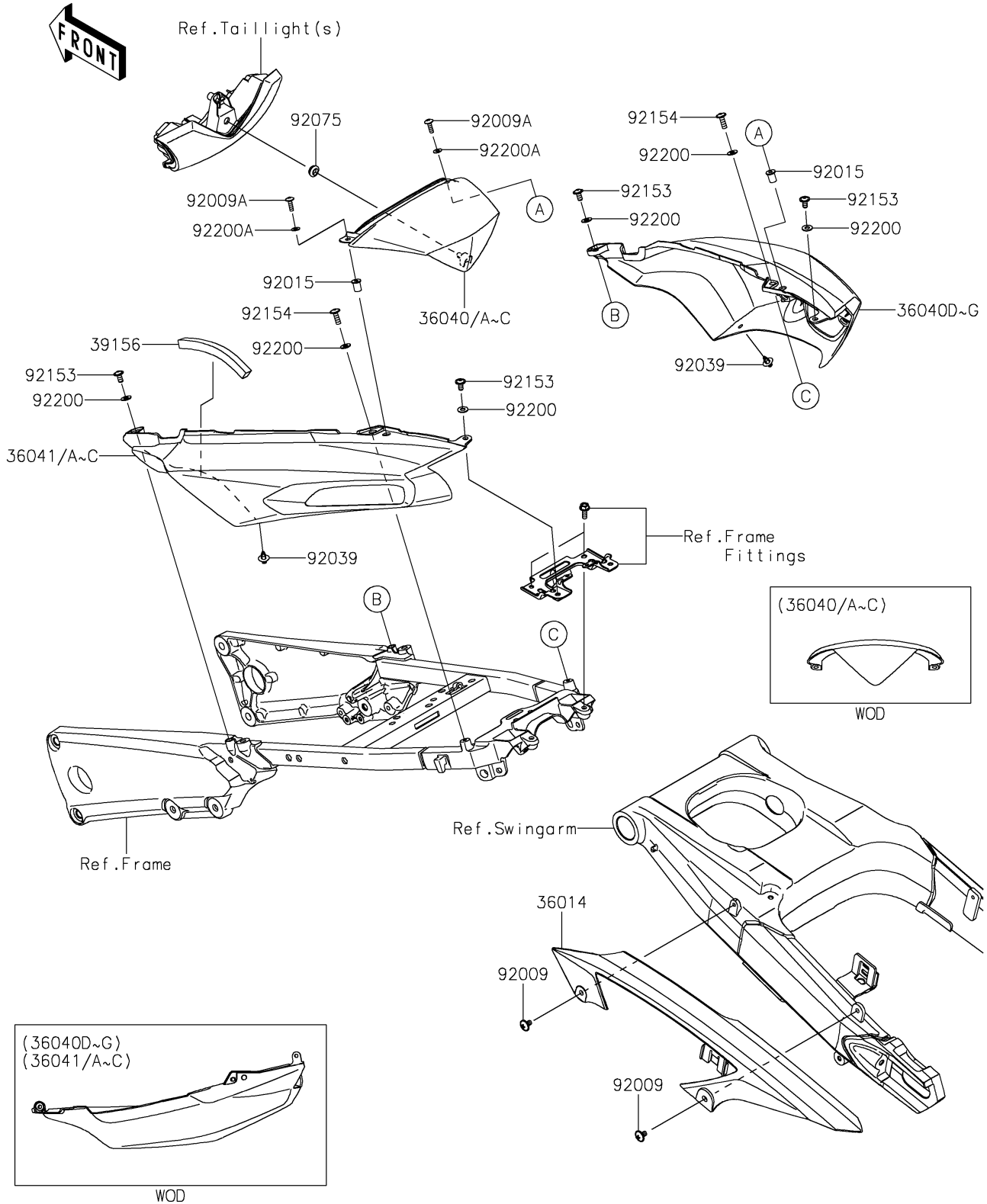

# 2024 Ninja ZX-14R ABS SE

## PARTS LIST

### Side Covers/Chain Cover

**ITEM NAME**

**PART NUMBER**

**QUANTITY**

---