

# 2022 NINJA® ZX™-14R ABS

## PARTS DIAGRAM

### Swingarm

F2141

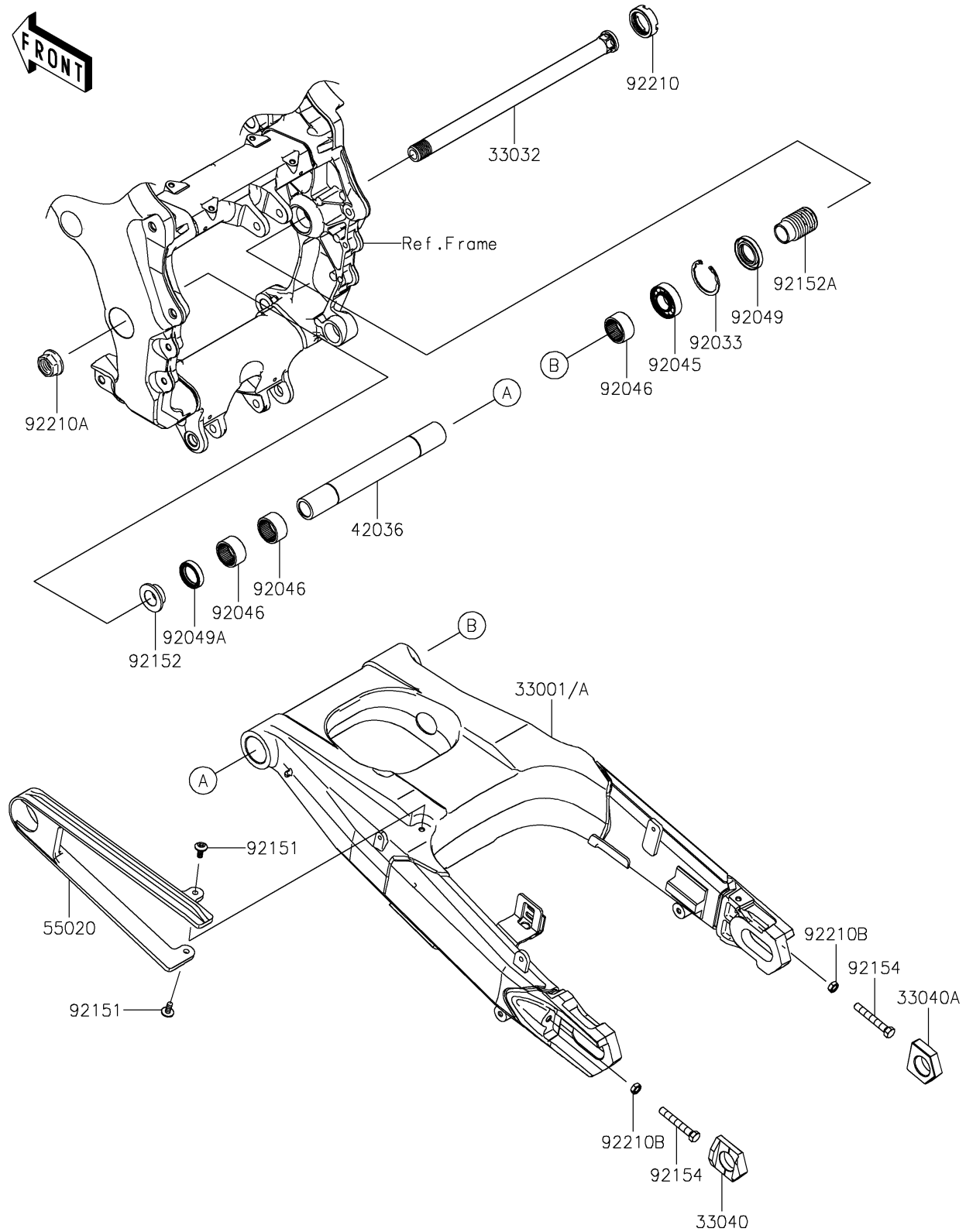

# 2022 NINJA® ZX™-14R ABS

## PARTS LIST

### Swingarm

ITEM NAME	PART NUMBER	QUANTITY
-----------	-------------	----------

---