

# 2022 NINJA H2<sup>®</sup>R

## PARTS DIAGRAM

### Footrests

F2160

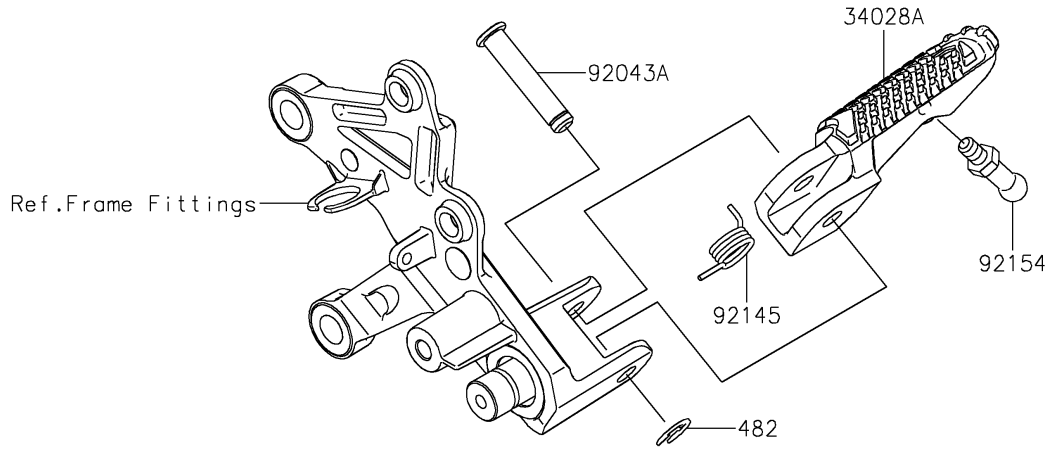

Ref. Frame Fittings

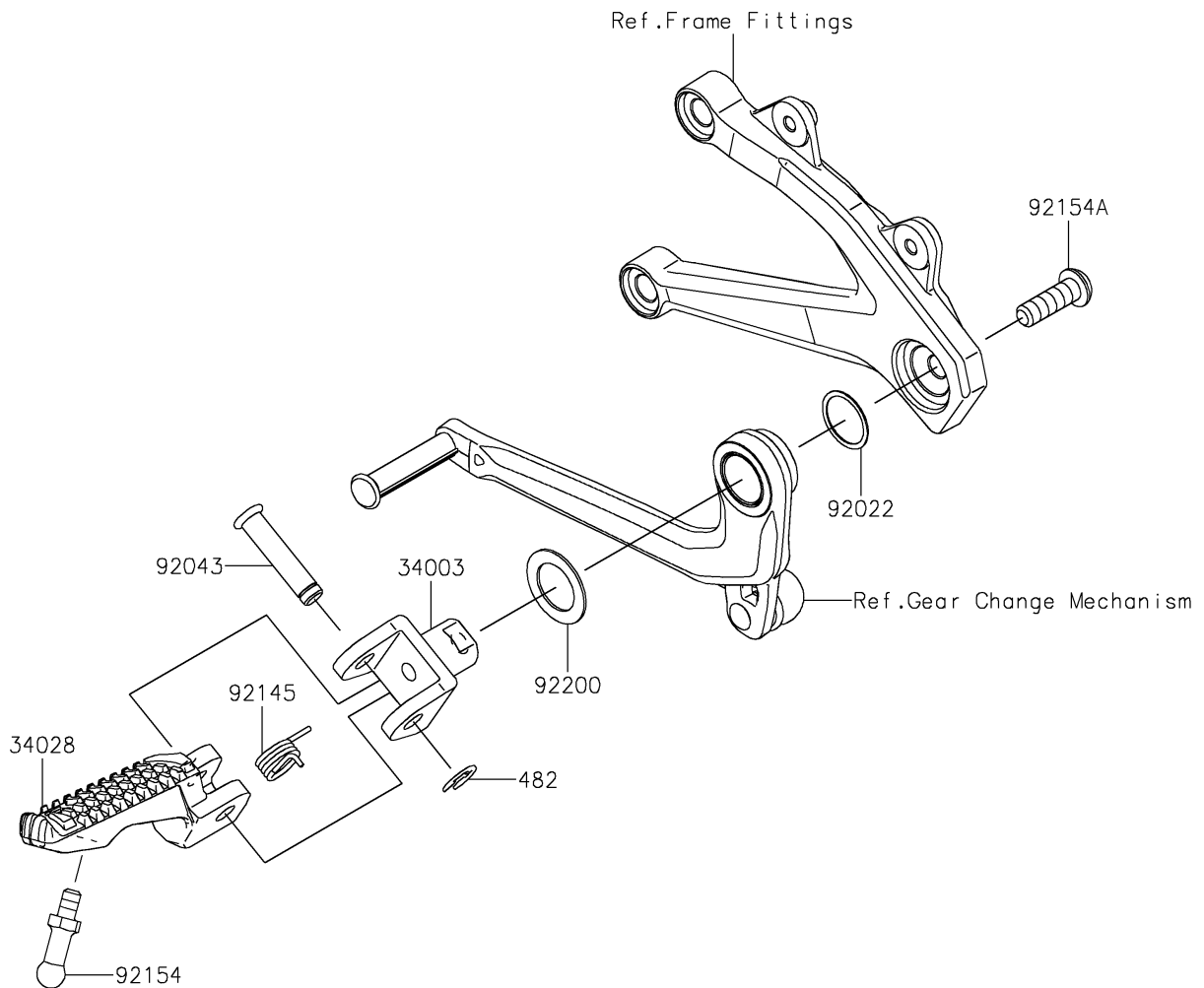

# 2022 NINJA H2<sup>®</sup> R

## PARTS LIST

### Footrests

**ITEM NAME**

**PART NUMBER**

**QUANTITY**

---