

# 2024 NINJA<sup>®</sup> 500

## PARTS DIAGRAM

### Ignition System

E1830

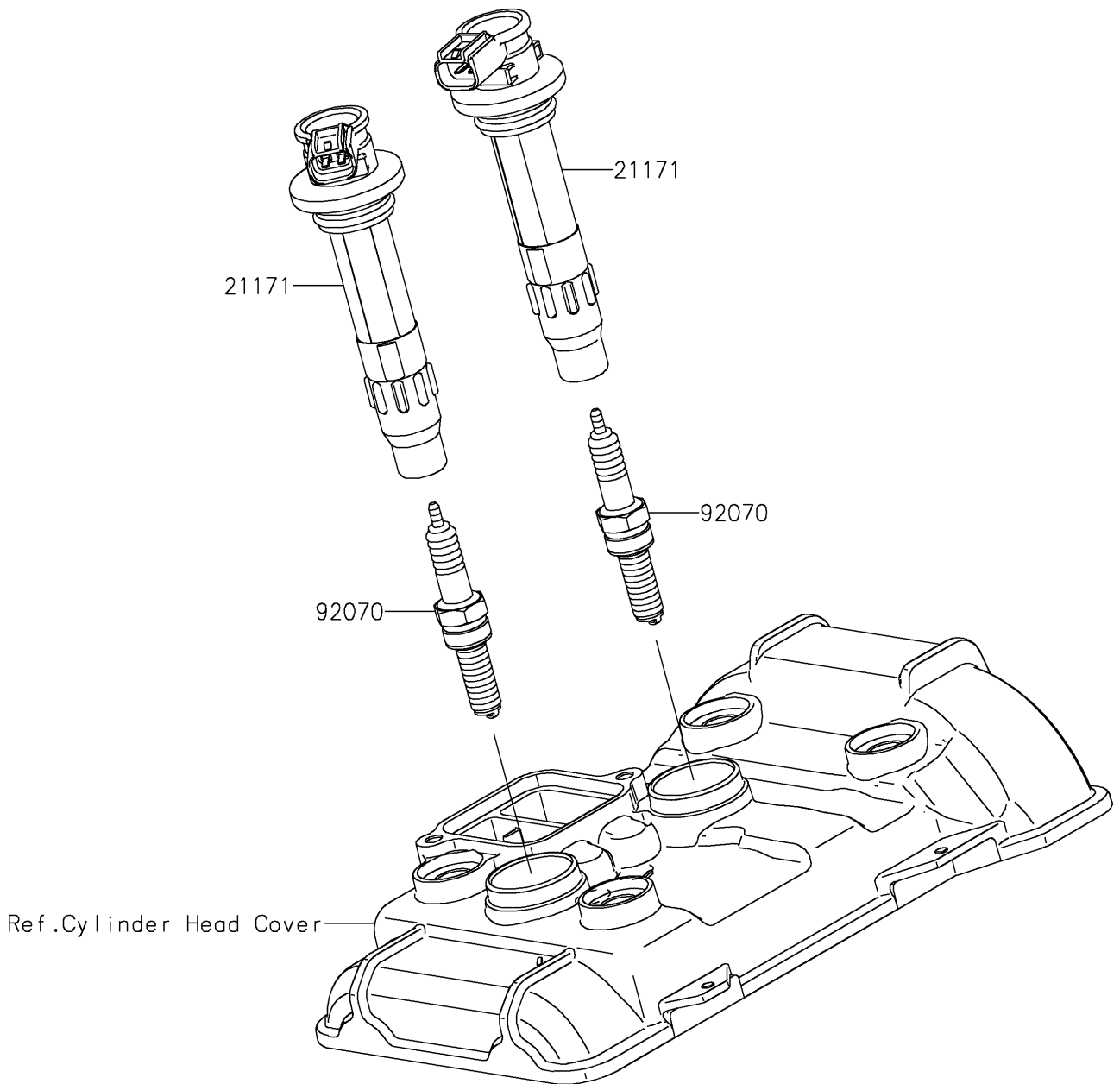

# 2024 NINJA<sup>®</sup> 500

## PARTS LIST

### Ignition System



ITEM NAME	PART NUMBER	QUANTITY
-----------	-------------	----------

---