

# 2024 NINJA® 500

## PARTS DIAGRAM

### Fuel Evaporative System(CA)

E1650

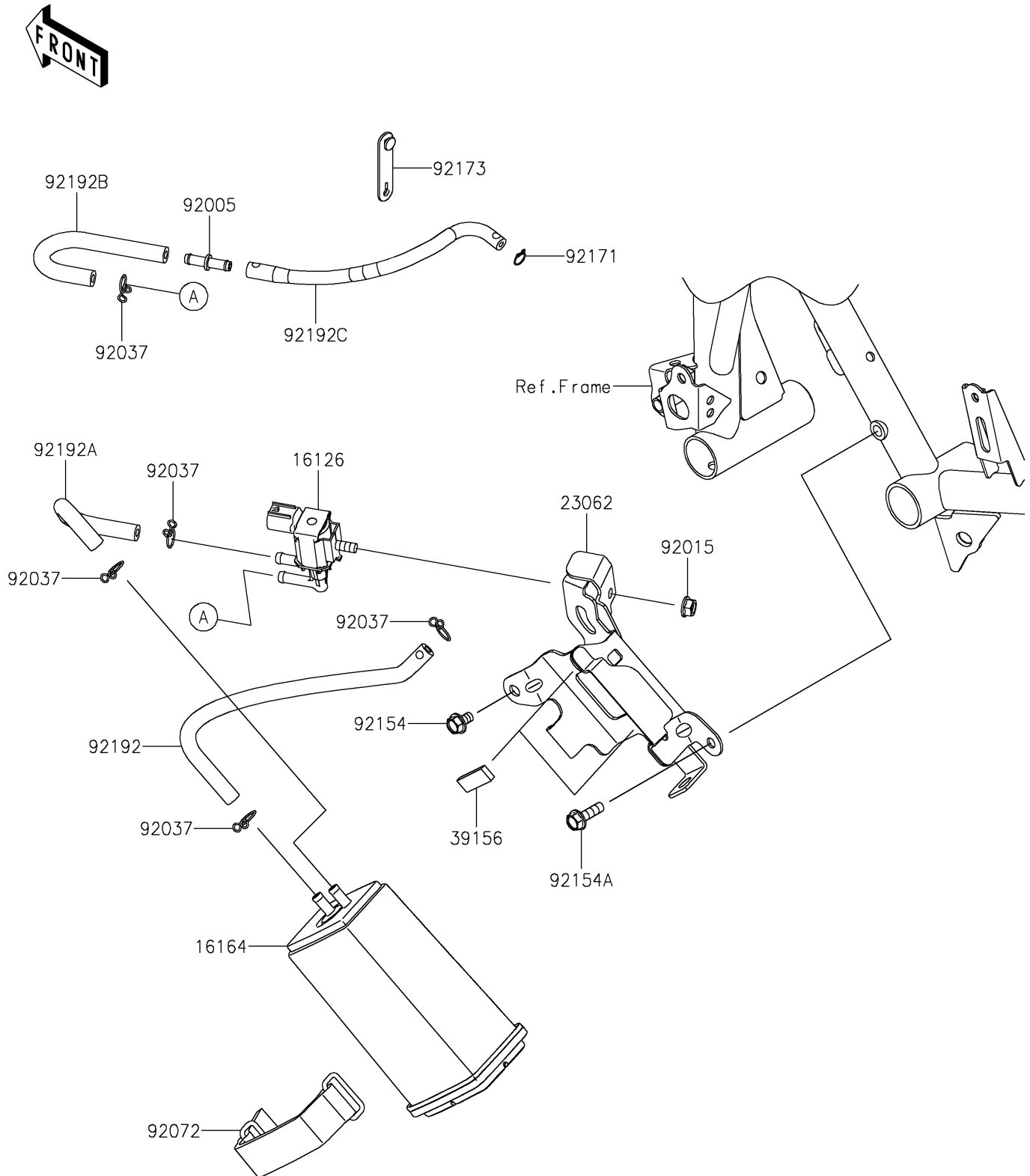

# 2024 NINJA<sup>®</sup> 500

## PARTS LIST

### Fuel Evaporative System(CA)

**ITEM NAME**

**PART NUMBER**

**QUANTITY**

---