

# 2025 Ninja 500

## PARTS DIAGRAM

### Valve(s)

E1210

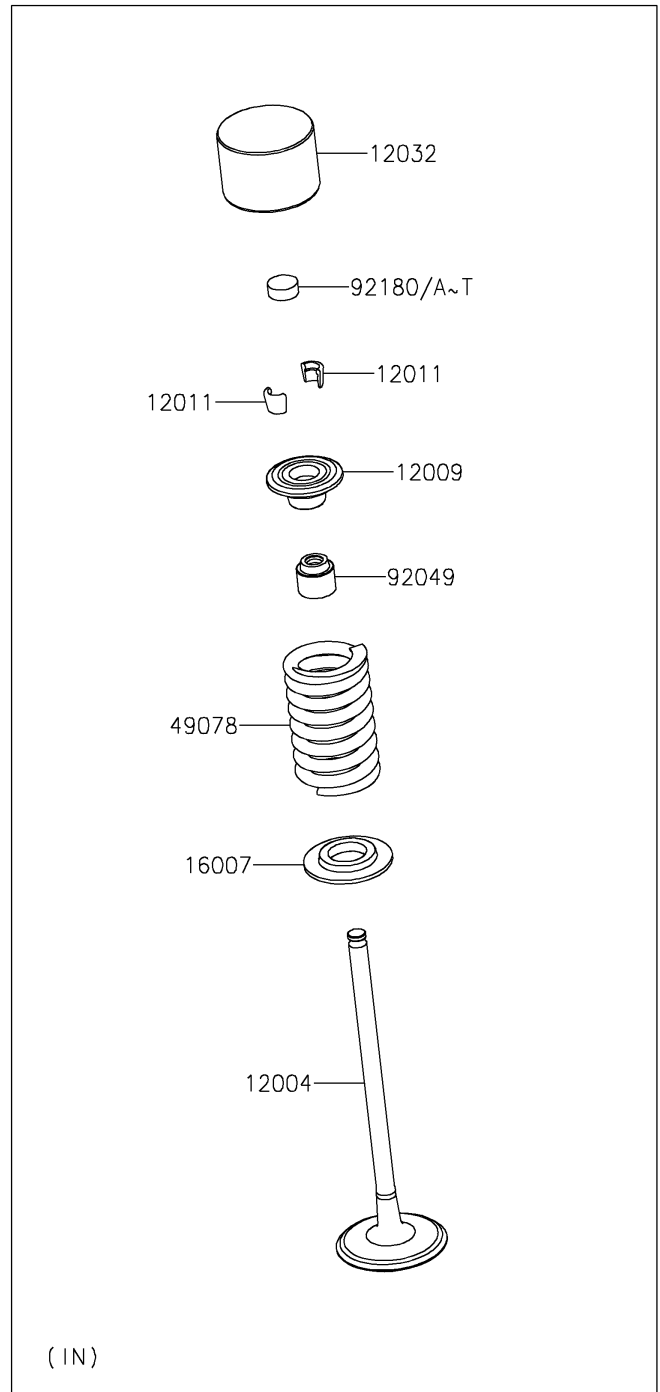

# 2025 Ninja 500

## PARTS LIST

Valve(s)

**ITEM NAME**

**PART NUMBER**

**QUANTITY**

---