

# 2025 NINJA® 500 ABS

## PARTS DIAGRAM

### Rear Fender(s)

F2172

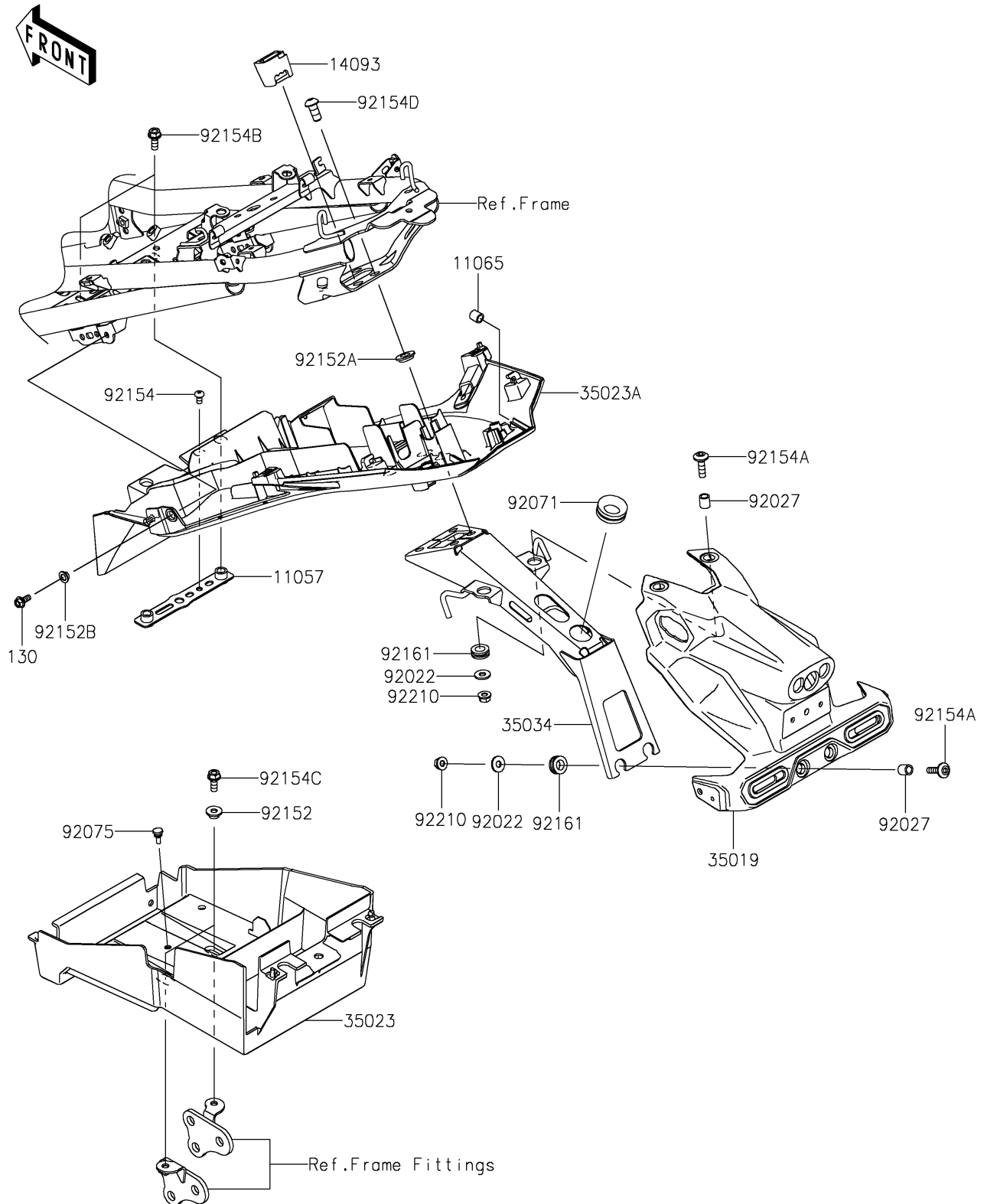

# 2025 NINJA<sup>®</sup> 500 ABS

## PARTS LIST

### Rear Fender(s)

ITEM NAME	PART NUMBER	QUANTITY
-----------	-------------	----------

---