

# 2025 NINJA® 500 ABS

## PARTS DIAGRAM

### Crankshaft

E1321

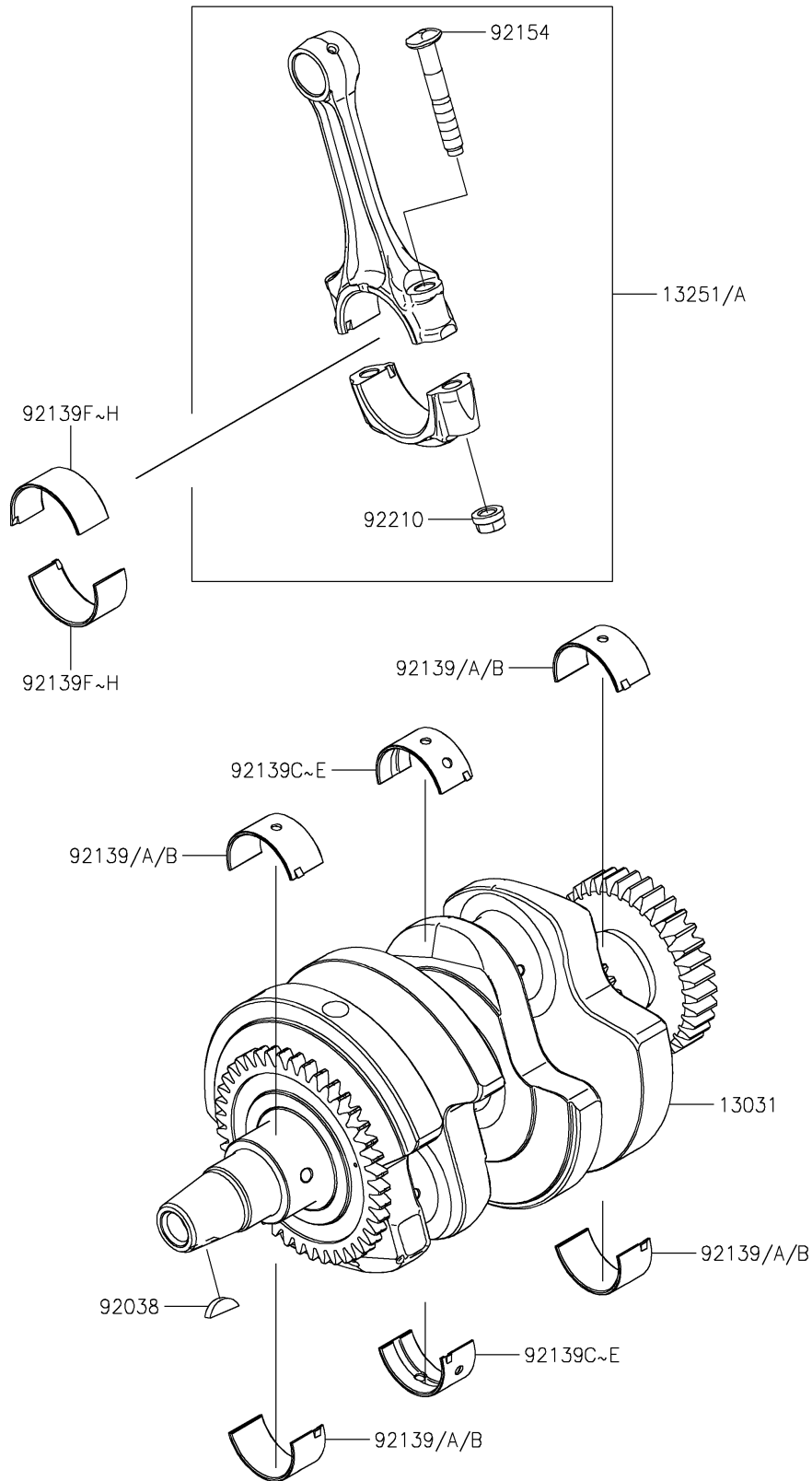

# 2025 NINJA® 500 ABS

## PARTS LIST

### Crankshaft

**ITEM NAME**

**PART NUMBER**

**QUANTITY**

---