

# 2002 Ninja® ZX™-6

## PARTS DIAGRAM

### Labels

F2860

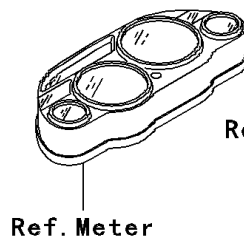
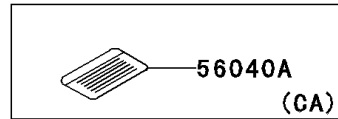
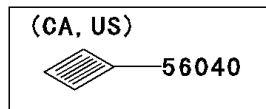
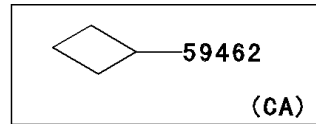
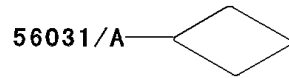
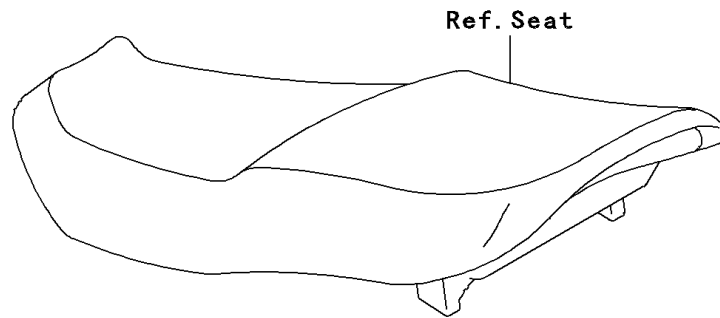

Ref. Fuel Tank

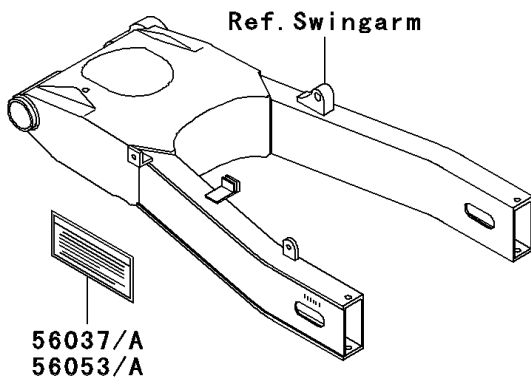
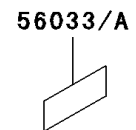
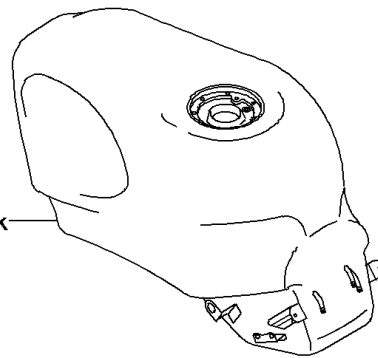

Ref. Side Covers/Chain Cover

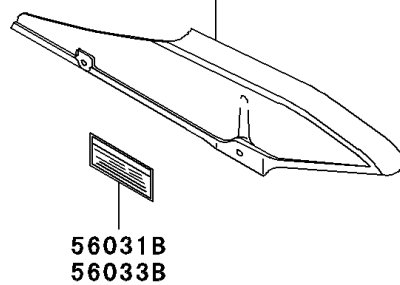

# 2002 Ninja® ZX™-6

## PARTS LIST

### Labels

ITEM NAME	PART NUMBER	QUANTITY
LABEL-MANUAL,CHAIN (Ref # 56031B)	56031-1982	1
LABEL-MANUAL,OIL&OIL FILTER (Ref # 56033)	56033-1283	1
LABEL-MANUAL,DAILY SAFETY (Ref # 56031)	56031-1841	1
LABEL-MANUAL,DAILY SAFETY (Ref # 56031A)	56031-1842	1
LABEL-SPECIFICATION,TIRE&LOAD (Ref # 56037)	56037-1777	1
LABEL-SPECIFICATION,TIRE&LOAD (Ref # 56037A)	56037-1778	1
LABEL-WARNING,BREAK IN CAUTION (Ref # 56040)	56040-1007	1
LABEL-WARNING,EVAPO (Ref # 56040A)	56040-1121	1
LABEL-CERTIFICATION,EVAPO ROUT (Ref # 59462)	59462-1520	1