

# 1991 Ninja® ZX™-6

## PARTS DIAGRAM

### Battery Case

F2132

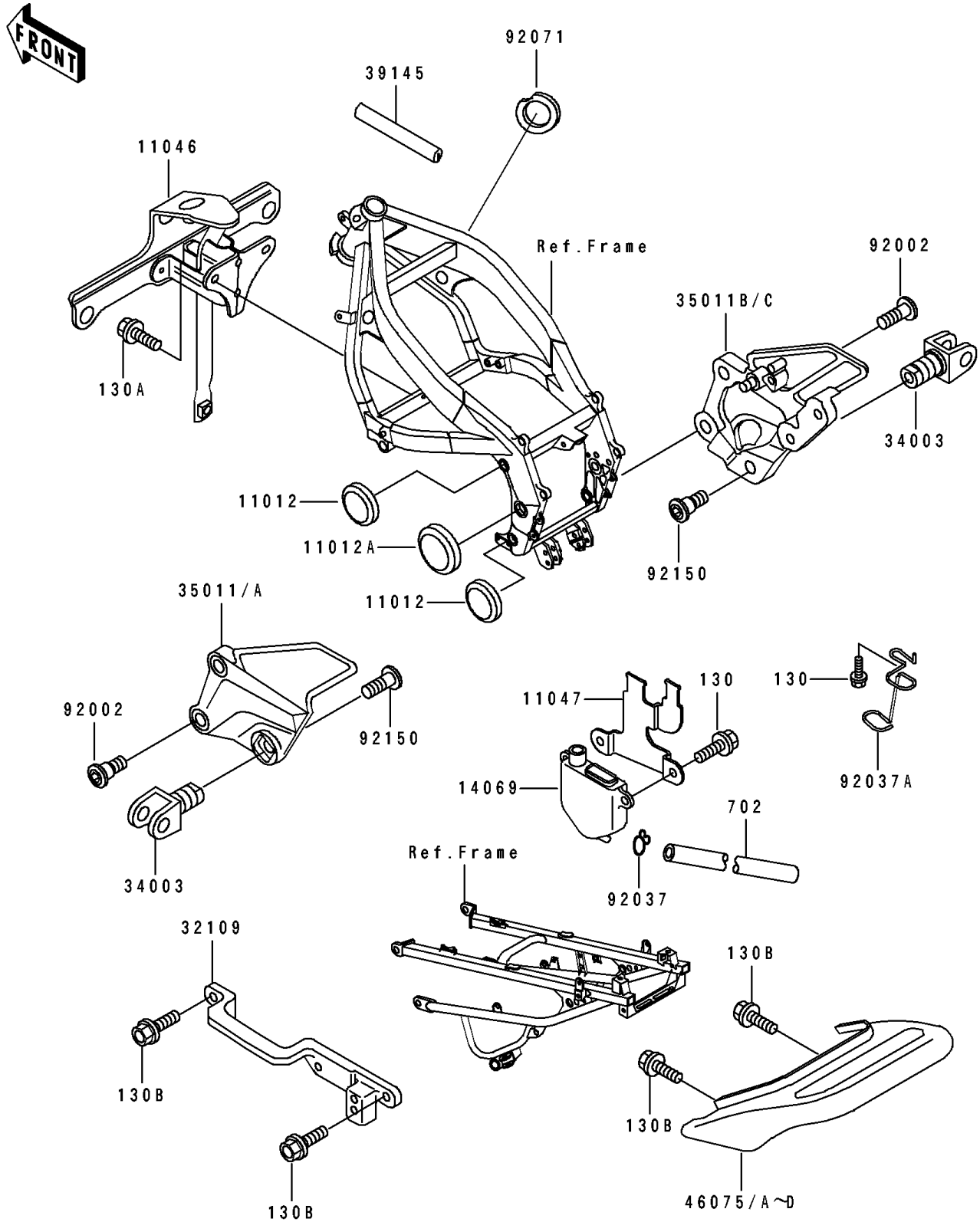

# 1991 Ninja® ZX™-6

## PARTS LIST

### Battery Case

ITEM NAME	PART NUMBER	QUANTITY
CAP (Ref # 11012)	11012-1460	4
CAP (Ref # 11012A)	11012-1657	2
BRACKET,RADIATOR (Ref # 11046)	11046-1963	1
BRACKET,RELAY (Ref # 11047)	11047-1113	1
BREATHER (Ref # 14069)	14069-1054	1
GRIP-FRAME,STAND (Ref # 32109)	32109-1206	1
HOLDER-STEP (Ref # 34003)	34003-1327	2
STAY,FR,LH,G.GRAY (Ref # 35011)	35011-1477-GD	1
STAY,FR,LH,G.GRAY (Ref # 35011A)	35011-1477-HN	1
STAY,FR,RH,G.GRAY (Ref # 35011B)	35011-1478-GD	1
STAY,FR,RH,G.GRAY (Ref # 35011C)	35011-1478-HN	1
TRIM-SEAL (Ref # 39145)	39145-1089	2
GRIP,GRABRAIL,C.C.RED (Ref # 46075)	46075-1092-HR	1
GRIP,GRABRAIL,EBONY (Ref # 46075B)	46075-1092-H8	1
GRIP,GRABRAIL,C.C.RED (Ref # 46075C)	46075-1092-L1	1
BOLT,SOCKET,8X20 (Ref # 92002)	92002-1493	4
CLAMP,TUBE (Ref # 92037)	92037-147	1
CLAMP,HOSE (Ref # 92037A)	92037-1875	1
GROMMET (Ref # 92071)	92071-1194	2
BOLT,SOCKET,10X25 (Ref # 92150)	92150-1268	2
BOLT-FLANGED (Ref # 130)	130J0610	3
BOLT-FLANGED,6X14,BLACK (Ref # 130A)	130J0614	2
BOLT-FLANGED,8X20 (Ref # 130B)	130J0820	4
TUBE-RUBBER,7X10X380 (Ref # 702)	702A07380	1