

# 2025 MULE™ 4010 4x4

## PARTS DIAGRAM

### Labels

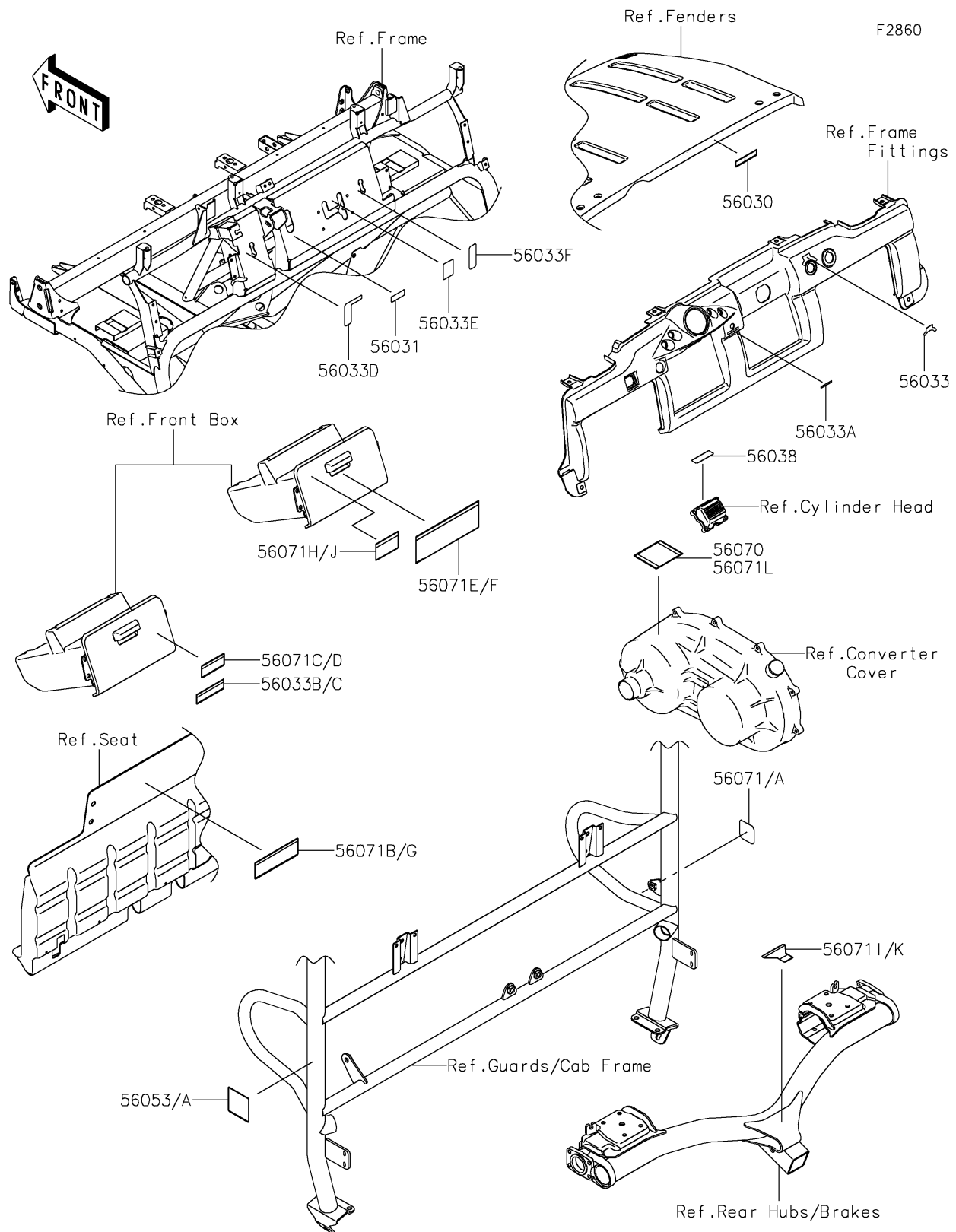

# 2025 MULE™ 4010 4x4

## PARTS LIST

### Labels



**ITEM NAME**

**PART NUMBER**

**QUANTITY**

---